



# AL-Series

*Standard Duty Commercial Locks*



*Standard Duty Commercial*

*For exterior and interior doors of medical, office, hotel/motel, public buildings, religious, multi-family, retail/storefront and government facilities. Also ideal for heavy duty residential use.*

*Performance Features*

Heavy duty compression springs extend life of spring cage and provide smooth, fast return action of levers and minimize droop.

True through-bolting prevents lock chassis rotation and disengagement from latch.

Stainless steel interlocking spindle design for added strength against excess force.

Cold rolled steel, machined, threaded hubs and locking nuts prevent loosening of the lockset by bolting chassis to the door.

Heavy duty cast mounting plate with specially tapped holes keeps lockset tight on door. Large diameter of mounting plate and rose covers new ANSI hollow metal door cutout.

Patented door range adjuster allows quick and easy adjustment of the AL-Series for 1<sup>3</sup>/<sub>8</sub>" to 1<sup>7</sup>/<sub>8</sub>" (35 mm to 48 mm) thick doors.

A wide variety of designs, functions and finishes are available to match any architectural need. Most lever styles and finishes match our mortise locks (L-Series), CM electronic locks, Von Duprin Exit Devices and LCN closers.

*Cutaway View*

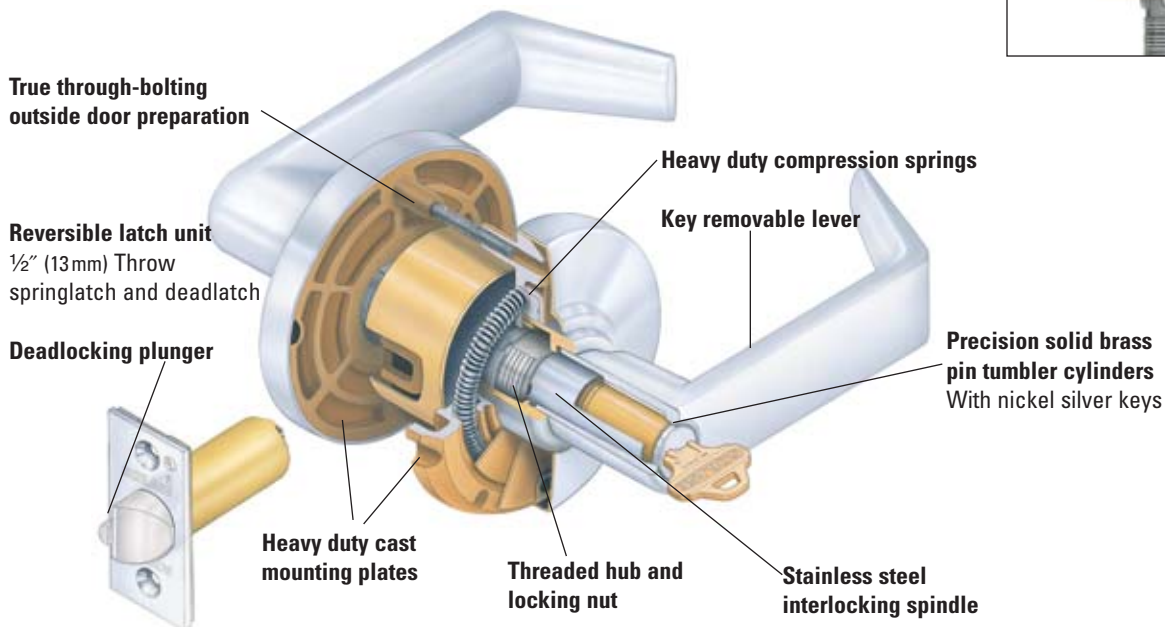

*On our cover, the AL-Series Saturn in Bright Chrome (625).*

INDEX	
Cutaway View	i
Cylinders	4 - 5
Designs & Finishes	2
Door Preparation	1
Functions	3
How to Order	8
Interchangeable Core	4 - 5
Latches	6
Performance Features	i
Primus® High Security Cylinders	4
Specifications	1
Strikes	7
Warranty	1

## Specifications

### Handing:

Non-handed.

### Door Thickness:

1 $\frac{3}{8}$ " to 1 $\frac{7}{8}$ " (35 mm to 48 mm) standard.

2" (51 mm) optional.

### Backset:

2 $\frac{3}{4}$ " (70 mm) standard. 2 $\frac{3}{8}$ " (60 mm), 3 $\frac{3}{4}$ " (95 mm) and 5" (127 mm) optional.

### Front:

Steel. 2 $\frac{1}{4}$ " x 1 $\frac{1}{8}$ " square corner, beveled, for 2 $\frac{3}{4}$ " backset standard. Optional 1" square corner, 1" radius corner, and non-UL drive-in / round face. For availability with specific backsets, see page 6.

### Lock Chassis:

Steel, zinc dichromated for corrosion resistance.

### Latch Bolt:

Brass, chrome plated,  $\frac{1}{2}$ " throw, deadlocking on keyed and exterior functions.

### Exposed Trim:

Wrought brass and bronze. Levers are pressure cast zinc, plated to match finish symbols.

### Strike:

ANSI curved lip strike 4 $\frac{7}{8}$ " x 1 $\frac{1}{4}$ " x 1 $\frac{1}{4}$ " lip to center standard. Optional strikes, lip lengths and ANSI wrought strike box available. See page 7.

### Cylinder & Keys:

6-pin patented Everest C123 keyway standard with two nickel silver keys per lock.

### Keying Options:

Interchangeable core and Primus® high security cylinders. Master keying, grand master keying, and construction keying.

### Warranty:

Three-year limited.

## Certifications

### ANSI

Meets or exceeds A156.2 Series 4000, Grade 2 strength and operational requirements.

Meets A117.1 Accessibility Code.

### Federal

Meets FF-H-106C.

### California State Reference Code

(Formerly Title 19, California State Fire Marshal Standard)

All levers with returns comply; levers return to within  $\frac{1}{2}$ " of door face.

### UL / cUL:

All locks listed for A label single doors, 4' x 8'.

Letter F and UL symbol on latch front indicate listing.

UL437 Listed locking cylinder optional: specify

Primus 20-500 Series cylinder.

## Door Preparation

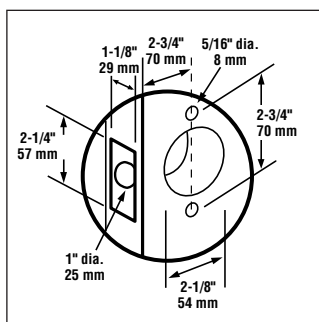

*Designs & Finishes*



613

**JUPITER**

Symbol: JUP  
 Material: Pressure cast zinc lever; wrought brass or bronze rose  
 Finishes: 605, 606, 612, 619, 613, 625, 626



Matches  
 D-Series *ATHENS*  
 and L-Series *07*  
 designs

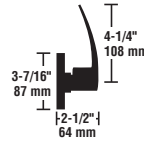

605

**NEPTUNE**

Symbol: NEP  
 Material: Pressure cast zinc lever; wrought brass or bronze rose  
 Finishes: 605, 606, 612, 619, 613, 625, 626



Matches  
 D-Series *SPARTA*  
 and L-Series *17*  
 designs

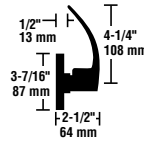

626

**SATURN**

Symbol: SAT  
 Material: Pressure cast zinc lever; wrought brass or bronze rose  
 Finishes: 605, 606, 609, 612, 613, 619, 625, 626



Matches  
 D-Series *RHODES*  
 and L-Series *06*  
 designs

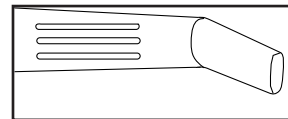
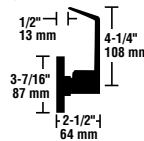

**TACTILE WARNING (KNURLING)**

Symbol: 8SA  
 Available Saturn design only. Outside lever is knurled unless otherwise specified.



626

**OMEGA**

Symbol: OME  
 Material: Pressure cast zinc lever; wrought brass or bronze rose  
 Finishes: 605, 606, 609, 612, 613, 619, 625, 626



Matches  
 D-Series *OMEGA*  
 and L-Series *OMEGA*  
 designs

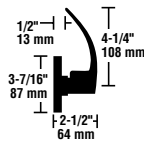

**Finishes**

- 605 Bright Brass
- 606 Satin Brass
- 609 Antique Brass
- 612 Satin Bronze
- 613 Oil Rubbed Bronze
- 619 Satin Nickel
- 625 Bright Chromium Plated
- 626 Satin Chromium Plated



This icon designates designs available with interchangeable core options.

*Functions*

ANSI A156.2 Series 4000 Grade 2

**Non-Keyed Functions**

SCHLAGE      ANSI

**AL10S      F75 Passage Latch**  
Both levers always unlocked.

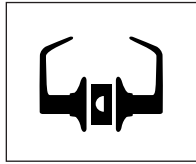

**AL25D      Exit Lock**  
Blank plate outside. Inside lever always unlocked. Specify door thickness, 1 3/8" (35 mm) or 1 3/4" (44 mm).

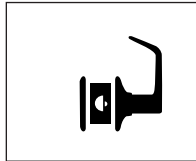

**AL40S      F76 Bath/Bedroom Privacy Lock**  
Push-button locking. Can be opened from outside with small screwdriver. Turning inside lever or closing door releases button.

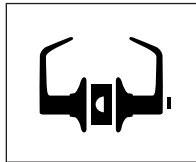

**AL44S      Hospital Privacy Lock**  
Push-button locking. Unlocked from outside by turning emergency turn button. Turning inside lever or closing door releases button.

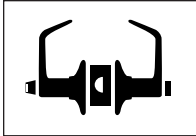

**AL170      Single Dummy Trim**  
Single dummy trim for one side of door. Used for door pull or as matching inactive trim.

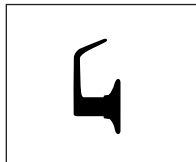

**Keyed Functions**

SCHLAGE      ANSI

**AL50PD      F82 Entrance/Office Lock**  
Push-button locking. Push-button locks outside lever until unlocked with key or by rotating inside lever.

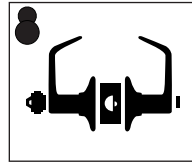

**AL53PD      F109 Entrance Lock**  
Turn/push-button locking; pushing and turning button locks outside lever requiring use of key until button is manually unlocked. Push-button locking; pushing button locks outside lever until unlocked by key or by turning inside lever.

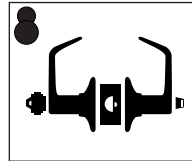

**AL70PD      F84 Classroom Lock**  
Outside lever locked and unlocked by key. Inside lever always unlocked.

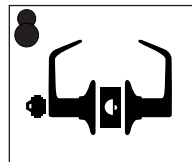

**AL80PD      F86 Storeroom Lock**  
Outside lever fixed. Entrance by key only. Inside lever always unlocked.

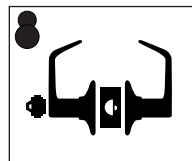

**AL85PD      F93 Hotel/Motel Lock**  
Outside lever fixed. Entrance by key only. Push-button in inside lever activates visual occupancy indicator, allowing only emergency masterkey to operate. Rotating inside lever or closing door releases visual occupancy indicator. Rotation of inside spanner button provides lockout feature by keeping indicator thrown.

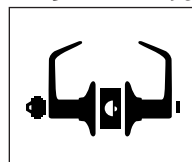

 This icon designates functions available with interchangeable core options.

## Standard Cylinders

Schlage® locks are provided with cylinders precision built to extremely close tolerances and the highest standards of accuracy. Using only solid brass plugs, extruded brass shells, phosphor bronze springs, nickel silver keys and pins, ensures long life and ease of operation. For complete listing of cylinder parts, refer to the AL-Series Service Manual.

## Primus® High Security Cylinders

Primus high security cylinders are available to add patented key control and varying degrees of geographical exclusivity to most Schlage 6-pin key systems, whether Everest or Classic keyways.

In addition to a conventional pin tumbler mechanism, Primus cylinders incorporate a patented finger pin and sidebar design providing a “dual-locking” cylinder that is virtually pick-proof. Resistance to drilling and other physical attack is optional by specifying 20-500 Series UL437 Listed cylinders.

### Cylinder for Most Functions

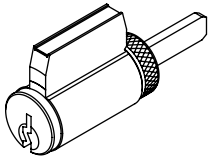

### Hotel Function Indicator Cylinder

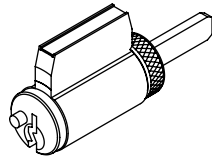

### Standard Cylinders

Number	Description
21-020	6-Pin conventional cylinder (standard)
20-728	Primus high security cylinder
20-528	Primus UL437 Listed high security cylinder
21-021	6-Pin Hotel Function (AL85) with occupancy indicator

Available 606 and 626 finish only. Everest C123 keyway standard.

## Interchangeable Core



Schlage® figure-8 interchangeable core (IC) locksets allow immediate rekeying at the door simply by using the special *control key* to replace the core in seconds.

IC locksets are available in Saturn design only, and can be ordered for either of two IC formats.



### SATURN

Symbol: SAT

Finishes: 605, 606, 612, 613, 619, 625, 626



626

### Full Size Interchangeable Core

Full size interchangeable cores can be integrated into any 5 or 6-pin Schlage key system.

To order complete locks with full size cores, change suffix from **PD** to **GD**. Example: AL53**RD**. To order locks *less core*, change suffix to **JD**. To order with full size *construction core*, change suffix to **TD**.

### Small Format Interchangeable Core (SFIC)

The SFIC version is designed for Schlage Everest B Family restricted keyway cores and is also completely compatible with Best®, Falcon, etc. small format cores.

To order complete locks with Everest B Family *restricted keyway cores*, change product suffix from **PD** to **GD** and provide letter of authorization from end user. Example: AL53**GD**. To order locks *less core*, change suffix to **BD**. To order with *keyed brass construction cores*, change suffix to **HD**. To order with *disposable plastic construction cores*, change suffix to **BDC**.

## Cores Only

### Full Size Core

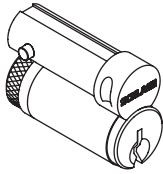

### Small Format Core

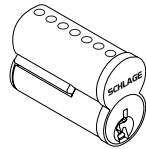

### Full Size Interchangeable Cores (For JD Suffix Locksets)

Number	Description
23-030	Conventional core
20-740	Primus high security core

Available 606 and 626 finish only. Everest C123 keyway standard.

### Small Format Interchangeable Cores (For BD Suffix Locksets)

Number	Description
80-036	7-Pin uncombined Everest B Family restricted keyways
80-037	7-Pin combined Everest B Family restricted keyways
80-043	6-pin uncombined Falcon / Best keyways
80-033	7-pin uncombined Falcon / Best keyways
M204-152	Disposable plastic construction core

Available 606 and 626 finish only. Specify keyway for existing systems.

80-033 and 80-043 cores are available in A, D, E, F, G, H, J, K, L, and M keyways.

80-036 and 80-037 restricted keyway cores require a letter of authorization from the end user. Schlage assigns the keyway when establishing new Everest restricted key systems.

## IC Conversion Kits

It is easy to convert standard AL Series locksets to accept Schlage full size interchangeable cores by changing the lever and adding the parts shown.

Conversion to SFIC requires different components, as well as dismantling the lockset to replace internal parts. No kits are available for this purpose.

### Full Size IC Conversion

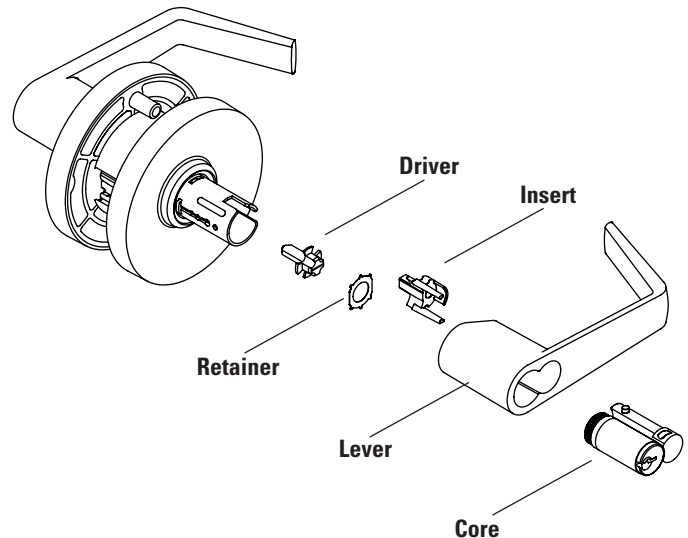

### Interchangeable Core Components

Number	Description
01-054 SAT*	Conversion kit: Driver, retainer, lever, core
01-025 SAT*	Conversion kit: Driver, retainer, lever
01-126	Driver, retainer
51-022 SAT*	Lever only (Saturn)

\*Specify finish.

## IC Installation Tool

This tool is used to install the driver and retainer for full size IC in the AL-Series and other Schlage cylindrical locksets. Its other ends are designed to install and remove mortise cylinder housings and test mortise cylinder cam action for both small format and full size interchangeable core cylinders.

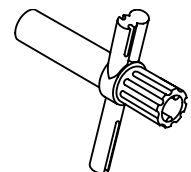

M504-413  
(Order separately.)

**Latches**

AL-Series latches are adjustable for flat or beveled edge doors. Latches and strikes are furnished in brass, bronze, or chrome finishes compatible with lock trim. When ordering separately, specify quantity, part number, and finish. Standard latch is shown in bold type.

**Square Corner Latches**

Springlatch

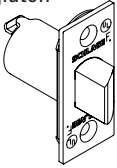

Deadlatch

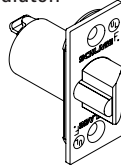

**Round Corner Latches**

Springlatch

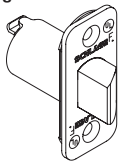

Deadlatch

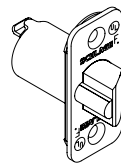

**Drive-In Latches**

Springlatch



Deadlatch

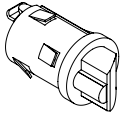

**Latch Front Adapter**

A501-878

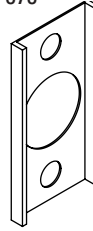

Used to convert 1" wide square front faceplates for 1 1/8" wide door preparations. Furnished in black plastic. Order in units of 100 each.

**Long Backsets**

Backsets 5" and over require extension links. AL-Series locks with long backsets are normally furnished with 1" faceplates and 7/8" housings. Links installed in 1" latch holes require one G506-815 sleeve (order separately) to join latch and link. Backsets over 5" require an additional sleeve placed 1/8" from lock chasis. Information on longer backsets is available upon request.

**5" Extension Link**

41-005

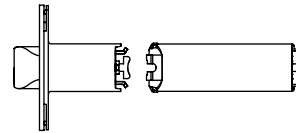

**Sleeve**

G506-815

(Order separately)



**Latches**

Backset	Faceplate Description	Hsg Dia	Deadlatch 1/2" (13mm) Throw	Springlatch 1/2" (13mm) Throw
2 3/8" (60mm)	1" x 2 1/4" (25mm x 57mm) square corner	7/8" (22mm)	11-085	11-068
	1" x 2 1/4" (25mm x 57mm) 1/4" (6mm) radius rnd. cnr.	7/8" (22mm)	11-088	11-069
	1" (25mm) circular drive-in (non-U.L.)	1" (25mm)	11-104	11-110
2 3/4" (70mm)	1" x 2 1/4" (25mm x 57mm) square corner	7/8" (22mm)	11-091	11-111
	1 1/8" x 2 1/4" (29mm x 57mm) square corner, <b>standard</b>	1" (25mm)	<b>11-096</b>	<b>11-116</b>
	1" x 2 1/4" (25mm x 57mm) 1/4" (6mm) radius rnd. cnr.	7/8" (22mm)	11-092	11-112
	1" (25mm) circular drive-in (non-U.L.)	1" (25mm)	11-105	11-113
3 3/4" (95mm)	1 1/8" x 2 1/4" (29mm x 57mm) square corner	1" (25mm)	11-103	11-118

**Door Reinforcement**

Schlage® 37-001 reinforcing unit is used to reinforce and help prevent the collapse of hollow metal doors when locksets are tightly mounted.

This kit should be used with long backsets for AL-Series lock installations in hollow metal doors to prevent lateral movement of the latchbolt. Specify door thickness, 1 3/8" (35mm) or 1 3/4" (44mm), when ordering reinforcement kits.

**Door Prep**

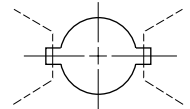

**Reinforcement Kit**

37-001

Sleeve  
A501-567

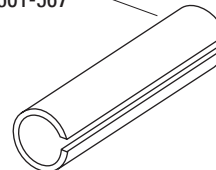

**Reinforcement**

A501-566 for 1 3/4" doors  
or  
A501-565 for 1 3/8" doors

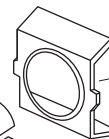



## Strikes

All Schlage strikes are furnished complete with screws. The 10-025 standard AL-Series strike has a 1 3/16" (30 mm) lip. When ordering separately, specify quantity, product number, finish, and lip length.

### Strikes

Number	Lip Length	Description
10-001	1", 1 1/8" (std), 1 1/4", 1 1/2", 1 3/4", 2" (25 mm, 29 mm, 32 mm, 38 mm, 44 mm, 51 mm)	1 1/8" x 2 3/4" (29 mm x 70 mm) Square corner
10-004	1 1/8" (29 mm)	1 1/8" x 2 3/4" (29 mm x 70 mm) 1/8" (3 mm) Radius, round cnr.
<b>10-025</b>	<b>1 9/16", 1 3/8"</b> (30 mm, 35 mm)	<b>1 1/4" x 4 7/8" (32 mm x 124 mm)</b> <b>ANSI, standard</b>
10-026	1 1/8" (29 mm)	1 5/8" x 2 1/4" (41 mm x 57 mm) Full lip, square corner
10-027	1 1/8" (29 mm)	1 5/8" x 2 1/4" (41 mm x 57 mm) Full lip, 1/4" (6 mm) radius, round corner
10-058	1 7/32" (31 mm)	1 3/4" (44 mm) Circular, adjustable
K510-066	—	Box, ANSI
39-030*	—	Rabbeted door adapter kit

### ANSI Strike – Standard

10-025

1 1/4" x 4 7/8" x 3/32"

(32 mm x 124 mm x 2 mm)

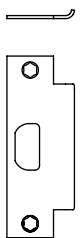

### T-Strike

10-001

1 1/8" x 2 3/4" x 3/32"

(29 mm x 70 mm x 2 mm)

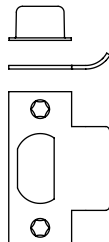

### Rabbeted Latch and Strike Kit

Rabbeted latch and strike kit finishes: 606, 626.

This kit adapts square corner latches and strikes for 1/2" (13 mm) rabbeted door and frame preparations.

### Rabbeted Latch and Strike Kit

39-030

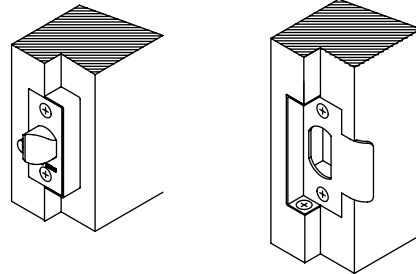







## How to Order

To order Schlage products, descriptive data should be in the same sequence as shown.

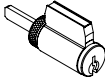
Line Item	Qty	Product	Outside		Inside		Latch	Strike	DR Thk	Dim	Additional Details
			Des	Fin	Des	Fin					
1	2	3	4	5	6	7	8	9	10	11	12

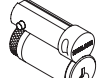
- 1 Line item number
- 2 Quantity
- 3 Complete model number with function and cylinder type

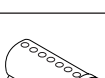
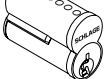
To order cylinder options, change "PD" at the end of the model number as follows:

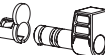
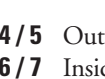
	AL53PD	Standard
	AL53LD	Less standard cylinder (For Primus cylinder, specify this option and order Primus cylinder separately.)
	AL53JD	Prepared for full size interchangeable core, less core (For Primus core, specify this option & order Primus core separately.)
	AL53RD	With full size conventional interchangeable core installed. Order control keys separately.
	AL53RD	With full size (temporary) construction core installed. Order control keys separately.
	AL53BD	Prepared for small format (Falcon, Best, etc.) interchangeable core (SFIC)
	AL53GD	With Everest B Family restricted keyway small format core installed. Order control keys separately.
	AL53HD	With small format keyed brass construction core installed. Order control keys separately.
	AL53BDC	With small format disposable plastic construction core installed.

- 4/5 Outside design / finish. Specify tactile warning (knurling) here as "8SA", available on Saturn only.
- 6/7 Inside design / finish. Leave blank if same as outside.
- 8 Latch. Leave blank for standard or specify part number for optional latch. LLL=Less Latch.
- 9 Strike. Leave blank for standard or specify part number for optional strike. LLL=Less Strike.
- 10 Door thickness, if non-standard. Example: 200 = 2".
- 11 Dimension for strike lip lengths. See strike page for availability of specific dimensions with specific strikes.
  - 100 = 1"
  - 118 = 1 1/8"
  - 114 = 1 1/4"
  - 138 = 1 3/8"
  - 112 = 1 1/2"
  - 134 = 1 3/4"
  - 200 = 2"
- 12 Keying detail (e.g. key symbol, keyway, bitting) and other special requirements.

### EXAMPLE

Line Item	Qty	Product	Outside		Inside		Latch	Strike	Dr Thk	Dim	Additional Details
			Des	Fin	Des	Fin					
1	24	AL10S	NEP	605				10-001			
2	5	AL50RD	SAT	613					200		C145 245793
3	60	AL85PD	JUP	626			11-085				E 000000

**Note:** Schlage order forms are available at no charge by contacting your IR Security & Safety Consultant or Customer Service.





Ingersoll Rand's Security Technologies Sector is a leading global provider of products and services that make environments safe, secure and productive. The Sector's market-leading products include electronic and biometric access control systems; time and attendance and personnel scheduling systems; mechanical locks and portable security, door closers and exit devices, steel doors and frames, architectural hardware and technologies and services for global security markets.

SCHLAGE  
111 Congressional Blvd., Suite 200  
Carmel, IN 46032  
800-847-1864  
800-452-0663 Fax

[www.schlage.com](http://www.schlage.com) [www.ingersollrand.com](http://www.ingersollrand.com)