

Your partner in mailbox and site solutions

## COMMERCIAL & RESIDENTIAL MAILBOX PRODUCTS SINCE 1934

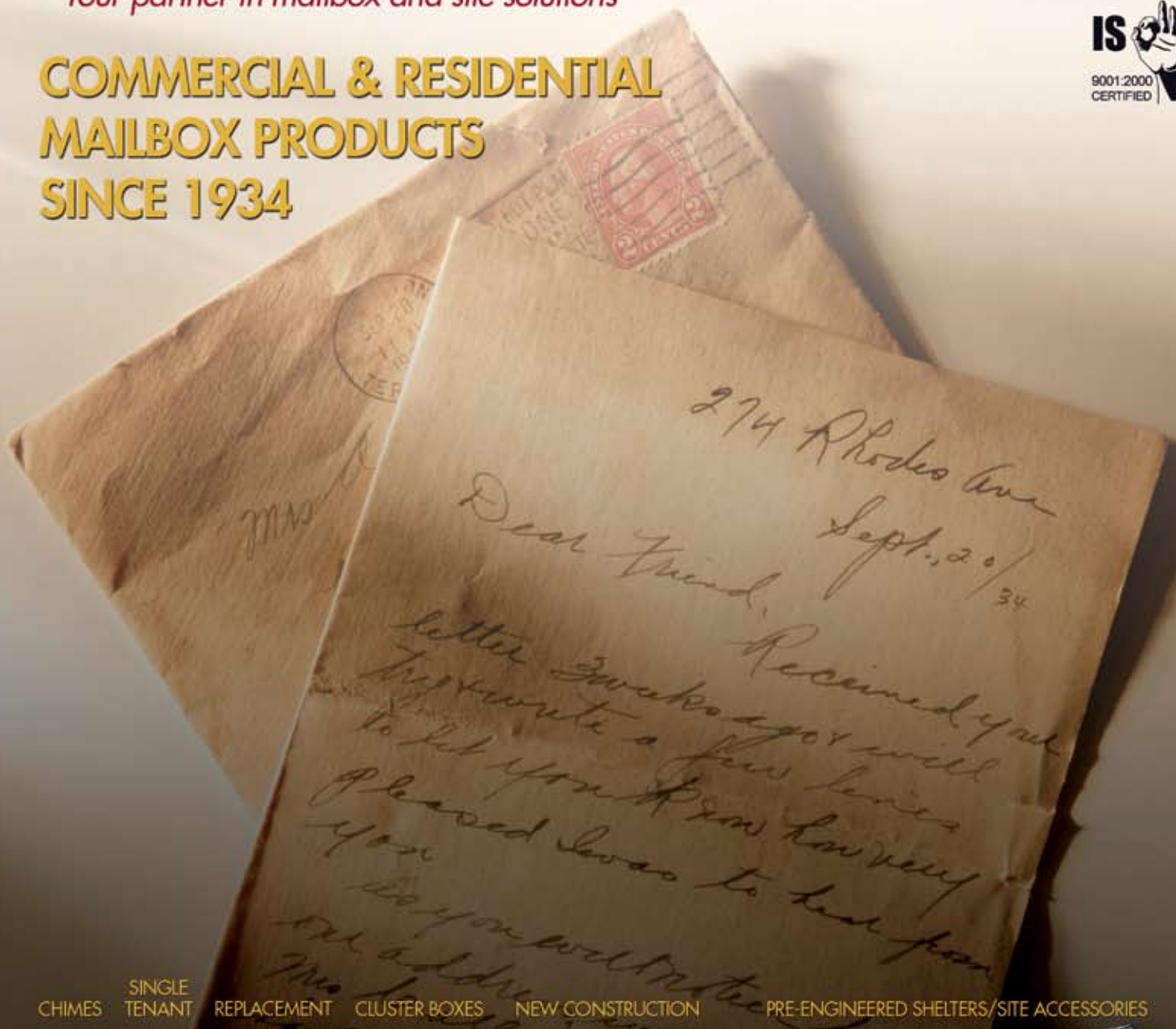

SINGLE TENANT REPLACEMENT CLUSTER BOXES NEW CONSTRUCTION PRE-ENGINEERED SHELTERS/SITE ACCESSORIES



POSTAL SPECIALTIES  
SECTION 10 55 00

Strategic partnership.  
Professional quality.  
Unsurpassed security.

Our long-standing partnership with the United States Postal Service (USPS), enables us to be the only manufacturer able to provide you with the highest quality products designed to meet the most stringent USPS standards. In 2005 for example, the United States Postal Service selected Florence Manufacturing as its **single source supplier** of cluster box units. We are proud to offer you the **same quality and security** the USPS depends on day in and day out.



Florence Manufacturing plant in Manhattan, KS

## Quality Manufacturer Since 1934

Centrally located to the U.S. in Manhattan, Kansas, Florence Manufacturing is proud to be the nation's oldest and leading supplier of mailboxes and mailbox accessories. Providing the most comprehensive product lines within the industry, we are a certified ISO 9001:2000 and Underwriters Laboratory audited manufacturer. Florence Manufacturing is a vertically integrated plant featuring on-site fabrication, state-of-the-art powder coating and robotic welding.



This cutting edge facility boasts a recycling program second to none with our powder reclamation program as well as extensive corrugate, steel and aluminum recycling programs.



## USPS Partnership

Florence Manufacturing continues to dedicate itself to providing secure postal speciality products built to the latest USPS standards. We are the only manufacturer authorized to provide F series cluster box units, outdoor parcel lockers and replacement pedestals and parts to the USPS since they awarded Florence Manufacturing their single-source contract for outdoor delivery equipment in 2005. We are also extremely proud to have been awarded the USPS Quality Supplier Award in 2003 and 2005 as well as most recently the prestigious USPS Supplier Excellence Award in 2006.





## Find an Authorized Florence Dealer

Florence Manufacturing is proud to have built relationships with the most extensive national dealer network in the industry. Authorized Florence Dealers are located from coast to coast and are ready to assist you from specification to final installation. By utilizing local expertise rather than buying direct from the factory, you are guaranteed personalized local service to meet your needs for each and every project. To find an Authorized Florence Dealer nearest you, visit us at [auth-florence.com](http://auth-florence.com) or call 800-275-1747.



## Do It Yourself Online Tools

Want to determine what your project needs are on your own? You can visit us at [auth-florence.com](http://auth-florence.com) 24/7 to configure a mail system that satisfies your specific project needs, browse product information, download technical documents and much more!

### Configurator

Florence Manufacturing's one-of-a-kind mailbox product/system configurator will help guide you step by step in creating a mail system to fit your individual needs. This unique system will also provide you with CAD drawings of your selection as well as access to quote your creation by an Authorized Florence Dealer. Simply visit [auth-florence.com](http://auth-florence.com) night or day to access this useful tool!



### Downloads

Looking for product specific drawings, technical information, color images, brochures or postal regulations? It's all located at [auth-florence.com](http://auth-florence.com). Simply click the downloads navigation tab for instant access to a multitude of technical, dimensional, and promotional material.



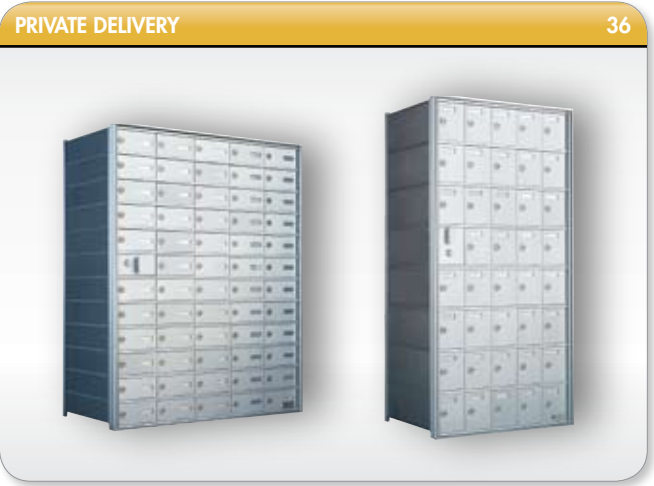

Florence Corporation..... 2

Postal Regulations, Accessibility Issues ..... 14 - 15

ID Options ..... 27

Lock Options ..... 31

Color Switch Options ..... 35

Replacement Mailbox Keys ..... 47

Service, Parts, Care/Cleaning, Warranty..... 48

Architectural Resources ..... 49

Index..... 50

Authorized Florence Dealers..... 51

**AF FLORENCE**  
 manufacturing company  
 800-275-1747      www.auth-florence.com

A GIBRALTAR INDUSTRIES COMPANY

**NEW From Florence Manufacturing**

Florence Manufacturing is proud to focus on Division 10 Postal Specialties; bringing you a quality product which continues to meet your ever changing needs. Look for these fine products throughout the catalog or discuss them with an Authorized Florence Dealer near you.



**NEW vital™ CBU colors**  
page 6

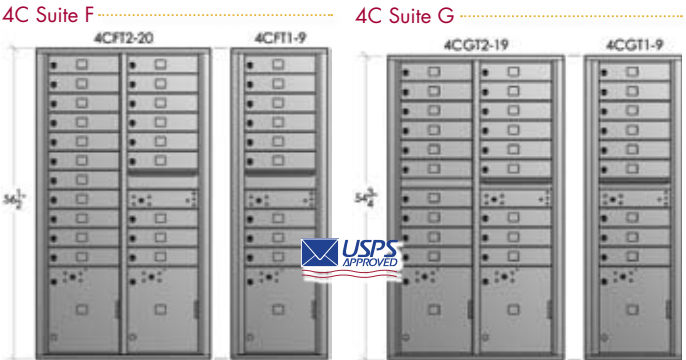

**NEW versatile™ 4C mailbox suites**  
page 13



**NEW valiant™ outdoor parcel locker**  
page 22



**NEW versatile™ 4C collars**  
page 11



**NEW versatile™ 4C rear-load**  
page 11



**NEW Hudson combination lock**  
page 30



**NEW Auth-Chimes sliding cover**  
page 44



**NEW vario™ pre-engineered mail shelter kits**  
pages 16 - 20



**NEW vogue™ CBU accessories**  
page 7



**NEW vicinity™ mail station accessories**  
Florence Site Furnishings/sentinel™ solar site lite  
page 21





## Durable, Multi-Compartment Mailboxes for Residential and Commercial Applications

The Florence vital™ 1570 series cluster box unit design has been adopted by the USPS as the design standard for all CBUs manufactured in the United States. As the original manufacturer of the F Series, Florence is pleased to offer a complete line of USPS approved cluster box units. To fit your individual project needs, we now offer six optional powder coat pebble finishes. We are honored to have been selected as the sole supplier of CBUs to the USPS and proud to offer you the same security and reliability that the USPS depends on every day.



1570-13SDAF shown  
in standard sandstone

### Standard Features

- Robotically welded cabinet and hood seams
- Rugged, weather resistant powder coat pebble finish resists scratching and vandalism
- Constructed of 300 series stainless steel and aircraft aluminum, including aluminum pedestal
- Master front loading door designed to prevent prying with interlocking overlap seams
- Solid aluminum mail slot frame, similar to Florence exclusive HSCBU design, protects adjacent customer compartment and collection compartment
- Silver adhesive metal placards with black numbers 1-16 and 1P-2P

### 1570-13SDAF Type IV

Installed height	62"
Depth	17-7/8"
Width	30-1/2"
Weight (with pedestal)	167 lbs.
Pedestal height	14-3/8"
Std. compartment	5"H x 12"W x 15"D

### NEW Powder Coat Color Options

#### Standard:

**Sandstone**  
PMS 7501C

#### Optional:

**White**  
PMS White

**Dark Bronze**  
PMS Black 7C

**Forest Green**  
PMS 3308C

**Black**  
PMS Black 6C

#### Replacement:

**Postal Grey**  
PMS 413C



**NEW** Accessories



Dress up your vital™ CBU with designer caps and pedestals. These snap-on accessories place the final touches on your community mailboxes. Ask your authorized Florence Dealer for details.

**Lock Type**

The vital™ CBU series comes standard with a K91910 lock in each tenant compartment door.



K91910

**ID Options**

- Custom placards 1-999 and 1P-99P
- Engraved numbers
- Black-filled engraved numbers



**1570-8SDAF**

Type I

Installed height	62"
Depth	17-7/8"
Width	30-1/2"
Weight (with pedestal)	144 lbs.
Pedestal height	28-1/2"
Std. compartment	3-1/4"H x 12"W x 15"D

**1570-12SDAF**

Type II

Installed height	62"
Depth	17-7/8"
Width	30-1/2"
Weight (with pedestal)	144 lbs.
Pedestal height	28-1/2"
Std. compartment	3-1/4"H x 12"W x 15"D

**1570-16SDAF**

Type III

Installed height	62"
Depth	17-7/8"
Width	30-1/2"
Weight (with pedestal)	175 lbs.
Pedestal height	14-3/8"
Std. compartment	3-1/4"H x 12"W x 15"D

USPS Approved  
New Construction

Mail Shelters and  
Site Amenities

USPS Approved

USPS Approved  
for Replacement

Private Delivery

Drop / Collection  
Boxes

Chimes

Postal Accessories,  
Locks and Parts





## Designed especially for and used by the United States Postal Inspection Service

The Florence vigilant™ 1565 series high security cluster box unit was designed specifically for the U.S. Postal Inspection Service. Built to combat mail theft and reduce break-in damage in high crime areas, its robust security features make the vigilant™ high security CBU incredibly secure. Available exclusively from an Authorized Florence Dealer, this product line is an extension of our already strong vital™ CBU series with the benefit of additional tamper resistant features. Give your neighborhood that extra peace of mind by adding a Florence vigilant™ high security CBU.



1565-16D shown in optional dark bronze

### Unique vigilant™ Features

- Thicker, reinforced gate
- Special security collar on all compartment locks
- Heavier gauge aluminum cabinet wrapper
- Larger diameter 1/4" hinge rod on all doors
- Reinforced shelf above and below the carrier access door to deter break-ins
- Stainless steel parcel door hinge for added strength
- Heavy duty stainless steel pedestal
- High security mounting hardware included

### Standard Features

- Robotically welded cabinet and hood seams
- Rugged, weather resistant powder coat pebble finish resists scratching and vandalism
- Constructed of 300 series stainless steel and aircraft aluminum, including stainless steel pedestal
- Master front-loading door designed to prevent prying with interlocking overlap seams
- Solid aluminum mail slot frame protects adjacent customer compartment and collection compartment
- Silver adhesive metal placards with black numbers 1-16 and 1P-2P

### Powder Coat Color Options

Standard:

**Sandstone**  
PMS 7501C

Optional:

**White**  
PMS White

**Dark Bronze**  
PMS Black 7C

**Forest Green**  
PMS 3308C

**Black**  
PMS Black 6C

Replacement:

**Postal Grey**  
PMS 413C

## 1565-16D

### Type III

Installed height	62"
Depth	17-7/8"
Width	30-1/2"
Weight (with pedestal)	186 lbs.
Pedestal height	14-3/8"
Std. compartment	3-1/4"H x 12"W x 15"D





**NEW Accessories**



Feel safe and secure with the **NEW** Florence sentinel™ solar site lite. This free-standing, solar light system is designed to fit perfectly around the base of Florence CBU or High Security CBUs, or can be used for other pedestrian settings with the in-ground option. (see page 21 for additional details)

**Lock Type**

The vigilant™ high security CBU series comes standard with a K92910 lock in each tenant compartment door.



K92910

**ID Options**

- Custom placards 1-999 and 1P-99P
- Engraved numbers
- Black-filled engraved numbers



**1565-8SDAF**

Type I

Installed height	62"
Depth	17-7/8"
Width	30-1/2"
Weight (with pedestal)	152 lbs.
Pedestal height	28-1/2"
Std. compartment	3-1/4"H x 12"W x 15"D



**1565-12SDAF**

Type II

Installed height	62"
Depth	17-7/8"
Width	30-1/2"
Weight (with pedestal)	156 lbs.
Pedestal height	28-1/2"
Std. compartment	3-1/4"H x 12"W x 15"D



**1565-13SDAF**

Type IV

Installed height	62"
Depth	17-7/8"
Width	30-1/2"
Weight (with pedestal)	177 lbs.
Pedestal height	14-3/8"
Std. compartment	5"H x 12"W x 15"D

USPS Approved  
New Construction

Mail Shelters and  
Site Amenities

USPS Approved

USPS Approved  
for Replacement

Private Delivery

Drop / Collection  
Boxes

Chimes

Postal Accessories,  
Locks and Parts



## Flexibility Without the Fuss

Versatile™ 4C mailbox suites meet or exceed all security requirements of the USPS STD-4C regulation for wall-mounted mail receptacles. Florence 4C mailboxes are constructed of heavy gauge aluminum and 300 series stainless steel components for superior strength, corrosion resistance and exceptional outdoor durability.

Our unique, patented double-locking parcel door mechanism makes sure your mail and packages stay safe and secure while our rugged, corrosion resistant powder coat finish resists scratching and vandalism to make sure your Florence versatile™ 4C mailbox system looks as appealing in the years ahead as it does the day you install it.



Powder Coat Color Options

- Sandstone  
PMS 7501C
- White  
PMS White
- Dark Bronze  
PMS Black 7C
- Forest Green  
PMS 3308C
- Black  
PMS Black 6C
- Silver Speck  
PMS 877C
- Blonde Gold\*  
PMS 7536C
- Postal Grey  
PMS 413C

\*Blonde Gold rated for indoor use only

4CAT8-19 shown in silver speck

### Standard Features

- Rugged, corrosion and weather resistant powder coat finish resists scratching and vandalism
- Constructed of heavy gauge aluminum and 300 series stainless steel components for superior strength, corrosion resistance and exceptional outdoor durability
- Master loading door designed with interlocking overlap seams to prevent prying
- Quick release master loading door lock latch for easy access by Postal carriers
- Solid aluminum mail slot frame, similar to high security CBU design, protects adjacent customer compartment and collection compartment
- Unique double-latching parcel locking mechanism design (patent pending)
- Front and rear (**NEW**) loading units available
- Prepared for number placards 1-20, 1P-3P
- Exclusive Florence multi-unit connector kit hardware (patent pending) included with every mailbox model for convenience and ease of installation





### NEW 4C Rear-Load



Florence Manufacturing is pleased to introduce a brand new USPS approved rear-load option for our extensive versatile™ 4C product line. When installed in a wall that opens into a secure room, our new exclusive design allows for faster mail delivery while still providing the smooth, sleek look you have come to depend upon. *(The rear-load dimensions are the same as our front-load options.)* Contact an Authorized Florence Dealer or visit [auth-florence.com](http://auth-florence.com) for additional product details.



### NEW 4C Collar



Don't have the wall depth to completely recess your versatile™ 4C mailbox suites? Not to worry, Florence Manufacturing has created a brand new collar for each module in the entire versatile™ 4C product line. This new collar allows you to mount your 4C mailbox suites while still giving your mail system a sleek, finished look. Contact an Authorized Florence Dealer or visit [auth-florence.com](http://auth-florence.com) for availability and additional product details.

### Lock Type

The versatile™ 4C series comes standard with a K91910 lock in each tenant compartment door.



K91910

### ID Options

- Custom placards 1-999 and 1P-99P
- Engraved numbers
- Black-filled engraved numbers

### Did you know?

Florence Manufacturing has the most extensive line of USPS STD-4C approved mailbox suites in the industry. An Authorized Florence Dealer can help you find just the right size product for your individual project needs.

### MUCK - Multi-Unit Connector Kit



Florence Manufacturing includes a specialized multi-unit connector kit (patent pending) with each 4C versatile™ mailbox module for easy installation of multiple 4C mailbox layouts in a single rough opening. Use of this hardware is optional depending upon project layout and installer preference. This unique kit helps to complete a beautiful, flush installation by eliminating the need for studs and reduces the separation between mailbox units.

USPS Approved  
New Construction

Mail Shelters and  
Site Amenities

USPS Approved  
Replacement

USPS Approved  
for Replacement

Private Delivery

Drop / Collection  
Boxes

Chimes

Postal Accessories,  
Locks and Parts



**No calculating or configuring needed ... just three easy steps:**

- 1) Mix 'n match our extensive USPS approved module options to suit your project's size and style.
- 2) Choose your compartment identification – use standard number placards or let us engrave the doors to suit your needs.
- 3) Select your finish color from eight architectural powder coat options. You're done!



4C Suite A

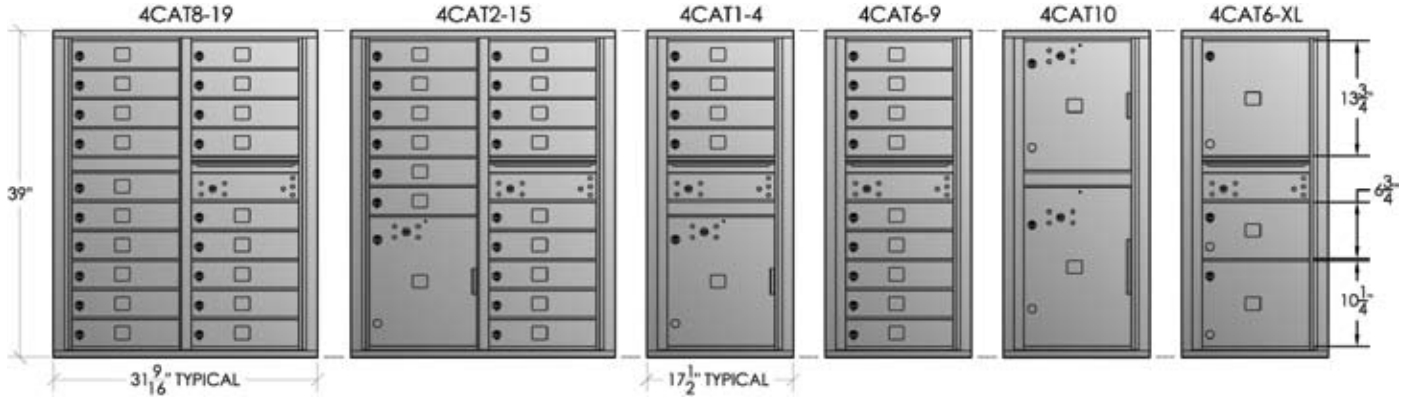

4C Suite B



4C Suite C

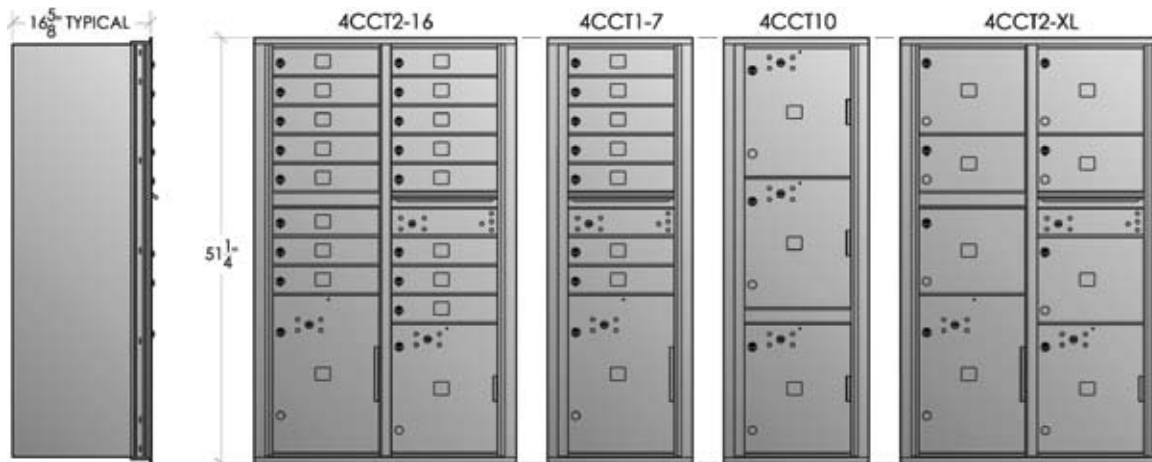

4C Suite D

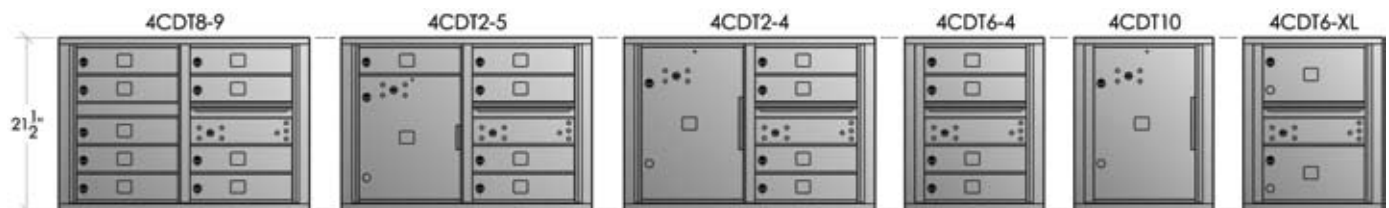



4C Suite E

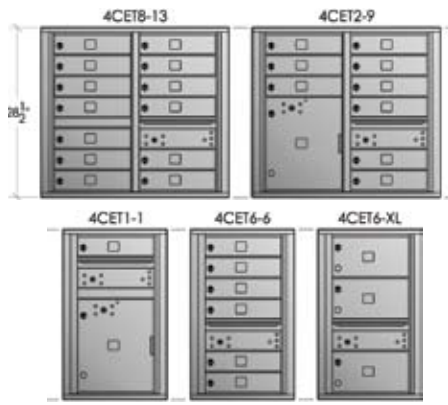

4C Suite F

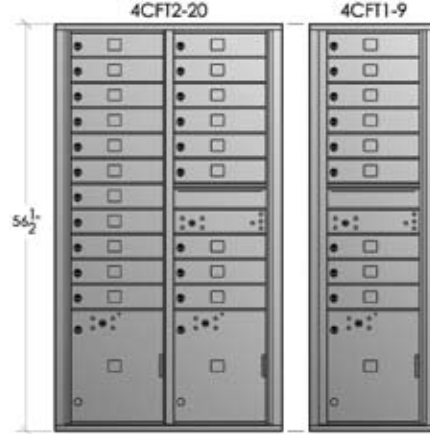

4C Suite G

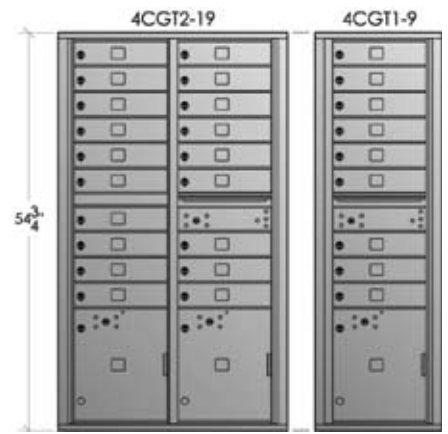

4C Dimension and Weight Chart

SUITE A 39" UNIT HEIGHT	ROUGH OPENING HEIGHT: 38-1/16"; ROUGH OPENING DEPTH: 17" Minimum						
	MODEL	RO WIDTH	ACTUAL WIDTH	WEIGHT (LBS)	# TENANTS	# PARCELS	
SUITE A 39" UNIT HEIGHT	4CAT8-19	30-5/16"	31-9/16"	120	19	0	
	4CAT2-15	30-5/16"	31-9/16"	115	15	1	
	4CAT1-4	16-1/4"	17-1/2"	63	4	1	
	4CAT6-9	16-1/4"	17-1/2"	67	9	0	
	4CAT10	16-1/4"	17-1/2"	55	0	2	
	4CAT6-XL	16-1/4"	17-1/2"	63	3	0	
SUITE B 18" UNIT HEIGHT	ROUGH OPENING HEIGHT: 17-1/16"; ROUGH OPENING DEPTH: 17" Minimum						
	MODEL	RO WIDTH	ACTUAL WIDTH	WEIGHT (LBS)	# TENANTS	# PARCELS	
	4CBT8-7	30-5/16"	31-9/16"	55	7	0	
	4CBT2-3	30-5/16"	31-9/16"	55	3	1	
	4CBT6-3	16-1/4"	17-1/2"	30	3	0	
	4CBT10	16-1/4"	17-1/2"	25	0	1	
SUITE C 51-1/4" UNIT HEIGHT <th colspan="6">ROUGH OPENING HEIGHT: 50-5/16"; ROUGH OPENING DEPTH: 17" Minimum</th>	ROUGH OPENING HEIGHT: 50-5/16"; ROUGH OPENING DEPTH: 17" Minimum						
	MODEL	RO WIDTH	ACTUAL WIDTH	WEIGHT (LBS)	# TENANTS	# PARCELS	
	4CCT2-16	30-5/16"	31-9/16"	145	16	2	
	4CCT1-7	16-1/4"	17-1/2"	75	7	1	
	4CCT10	16-1/4"	17-1/2"	67	0	3	
	4CCT2-XL	30-5/16"	31-9/16"	145	6	2	
SUITE D 21-1/2" UNIT HEIGHT	ROUGH OPENING HEIGHT: 20-9/16"; ROUGH OPENING DEPTH: 17" Minimum						
	MODEL	RO WIDTH	ACTUAL WIDTH	WEIGHT (LBS)	# TENANTS	# PARCELS	
	4CDT8-9	30-5/16"	31-9/16"	68	9	0	
	4CDT2-5	30-5/16"	31-9/16"	63	5	1	
	4CDT2-4	30-5/16"	31-9/16"	61	4	1	
	4CDT6-4	16-1/4"	17-1/2"	40	4	0	
SUITE E 28-1/2" UNIT HEIGHT <th colspan="6">ROUGH OPENING HEIGHT: 27-9/16"; ROUGH OPENING DEPTH: 17" Minimum</th>	ROUGH OPENING HEIGHT: 27-9/16"; ROUGH OPENING DEPTH: 17" Minimum						
	MODEL	RO WIDTH	ACTUAL WIDTH	WEIGHT (LBS)	# TENANTS	# PARCELS	
	4CET8-13	30-5/16"	31-9/16"	86	13	0	
	4CET2-9	30-5/16"	31-9/16"	86	9	1	
	4CET1-1	16-1/4"	17-1/2"	58	1	1	
	4CET6-6	16-1/4"	17-1/2"	58	6	0	
SUITE F 56-1/2" UNIT HEIGHT <th colspan="6">ROUGH OPENING HEIGHT: 55-9/16"; ROUGH OPENING DEPTH: 17" Minimum</th>	ROUGH OPENING HEIGHT: 55-9/16"; ROUGH OPENING DEPTH: 17" Minimum						
	MODEL	RO WIDTH	ACTUAL WIDTH	WEIGHT (LBS)	# TENANTS	# PARCELS	
	4CFT1-9	16-1/4"	17-1/2"	97	9	1	
	4CFT2-20	30-5/16"	31-9/16"	171	20	2	
	SUITE G 54-3/4" UNIT HEIGHT <th colspan="6">ROUGH OPENING HEIGHT: 53-13/16"; ROUGH OPENING DEPTH: 17" Minimum</th>	ROUGH OPENING HEIGHT: 53-13/16"; ROUGH OPENING DEPTH: 17" Minimum					
		MODEL	RO WIDTH	ACTUAL WIDTH	WEIGHT (LBS)	# TENANTS	# PARCELS
4CGT1-9		16-1/4"	17-1/2"	97	9	1	
4CGT2-19	30-5/16"	31-9/16"	171	19	2		

RO height and width on all models tolerant to +1/4"-0". RO height and width on all multi-unit installations tolerant to +1/8" -0".

Use this formula to calculate RO width for Multi-Unit 4C Installation = (the sum of all actual unit widths) - 1-1/8"



## New Construction Solutions

Florence Manufacturing takes great pride in providing comprehensive product lines to meet all your project needs - and the versatile™ 4C mailbox line is no exception!

This complete line of products gives you the versatility you need to complete your individual project while still adhering to the new mandatory USPS STD-4C regulation.

Before you begin construction, be sure to consult with an Authorized Florence Dealer who can assist you from specification to installation.

## NEW Postal Regulations

The STD-4C, which now applies to all Wall-Mounted Centralized Mail Receptacles, replaces the previous STD-4B+ regulation for Receptacles/Apartment/House Mail, and became mandatory in October 2006 for all new construction and major renovation projects. In order to determine the precise regulations which would make up the new STD-4C, the USPS created an Apartment Consensus Committee to generate feedback. The committee was comprised of various members (including Florence Manufacturing) who represented mailbox manufacturers, mailbox resellers and servicers, property owners and managers, and the USPS. This committee met for over one year to discuss and ultimately agree upon the requirements that now make up the mandatory STD-4C regulation.



The USPS STD-4C specification creates a new form factor and increases the minimum size requirement (12" W x 15" D x 3" H); completely eliminating the vertical form factor (5" W x 6" D x 15" H). STD-4C also requires one parcel locker per ten tenant compartments. Security features and lock design requirements are more stringent, which includes mandatory security testing done by the USPS. More product details as well as the full STD-4C regulations are available by contacting an Authorized Florence Dealer or by visiting [auth-florence.com](http://auth-florence.com).

Florence Manufacturing is pleased to offer the most in-depth line of USPS approved 4C products available on the market today. Our seven different lines of versatile™ 4C mailbox suites with thirty different modules offer flexibility without the fuss. Mix 'n match 4C modules to configure the perfect mailbox system to fit your project needs.



# versatile™ 4C Accessibility Details

Florence versatile™ 4C mailbox suites (Unit Heights)	Accessibility and Regulatory Standards Compliance			
	US Postal Service <sup>1</sup> STD-4C Installation	U.S. DOJ <sup>2</sup> ADA Standards	ICC/ANSI <sup>3</sup> A117.1 2003	IBC 2006 (Ref: ICC/ANSI) <sup>3</sup>
Suite A - 39"	YES	NO	NO	NO
Suite B - 18"	YES	YES	YES	YES
Suite C - 51-1/4"	YES	NO	NO	NO
Suite D - 21-1/2"	YES	YES	YES	YES
Suite E - 28-1/2"	YES	YES	NO	NO
Suite F - 56-1/2"	YES	NO	NO	NO
Suite G - 54-3/4"	YES	NO	NO	NO

<sup>1</sup>Standards Governing the Design of Wall-Mounted Centralized Mail Receptacles. Federal Register/Vol. 69, No 171/September 3, 2004/ Rules and Regulations POSTAL SERVICE, 39 CFR Part 111.

<sup>2</sup>ADA Standards for Accessible Design, Department of Justice Code of Federal Regulations, 28 CFR Part 36, Appendix A, Section 4.2 Space Allowance and Reach Ranges.

<sup>3</sup>Accessible and Usable Buildings and Facilities, International Code Council/American National Standard Institute (ICC/ANSI A117.1-2003), Chapter 3 Building Blocks, Section 308 Reach Ranges. NOTE: The 2006 International Building Code (IBC 2006) also refers to this ANSI Standard for accessibility building guidelines.

**Notes:**

All STD-4C compliant mailboxes must meet the U.S. Postal Service’s design and installation regulation in order to receive the “USPS Approved” designation. Accessibility regulations may vary locally and regionally. Therefore, always consult local building code authorities for applicable accessibility codes related to your mailbox project.

A “Yes” rating in the chart above was assigned only if ALL mailboxes in the entire Florence versatile™ suite met the referenced regulation. A 4C suite that has been assigned a “No” rating will have some rows of mailboxes that DO meet the accessibility regulation, but others which do not. This “Accessibility Guide” is designed to help you determine which Florence 4C mailbox suite meets your individual project specifications.

Sequential numbering (rather than assigning mailbox IDs that match apartment or house numbers) of mailbox compartments may allow greater flexibility in providing accessible mailbox compartments that meet accessibility regulations applicable in your area. Sequential numbering of mailbox compartments also provides greater security and privacy for your residents.

An Accessibility Guide for Florence’s versatile™ 4C mailbox suites is available to assist you in selecting USPS Approved STD-4C compliant mailboxes which meet your project requirements and local accessibility codes. You may download this reference document by visiting our website at [auth-florence.com/downloads](http://auth-florence.com/downloads), or by contacting your local Authorized Florence Dealer.

## Installation Instructions

Florence Manufacturing STD-4C product installation instructions adhere to USPS regulations. Other suite installation details are available by contacting your local Authorized Florence Dealer or by going online to [auth-florence.com](http://auth-florence.com).

Installation requirements specified in the U.S. Postal Service STD-4C regulation are outlined below:

1. At least one customer compartment shall be positioned less than 48 inches from the finished floor.
2. No parcel locker compartment (interior bottom shelf) shall be positioned less than 15 inches from the finished floor.
3. No patron (tenant) lock shall be located more than 67 inches above the finished floor.
4. No customer compartment (interior bottom shelf) shall be positioned less than 28 inches from the finished floor.
5. The USPS Arrow lock shall be located between 36 and 48 inches above the finished floor.

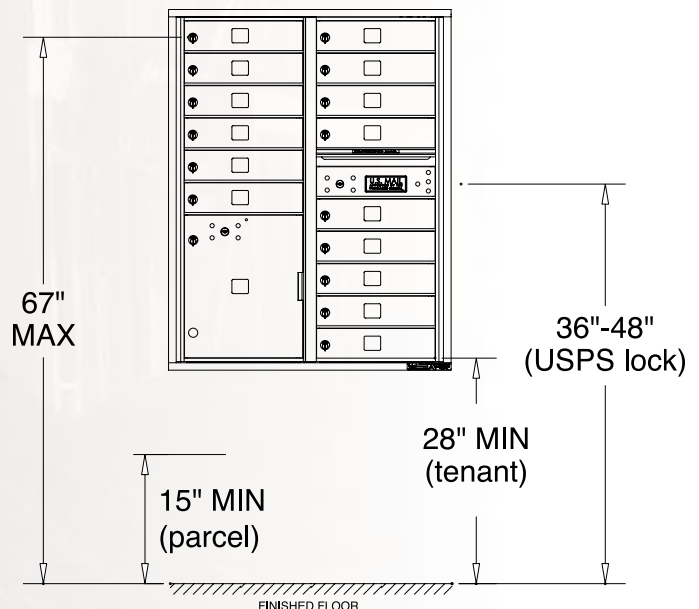

USPS Approved  
New Construction

Mail Shelters and  
Site Amenities

USPS Approved

USPS Approved  
for Replacement

Private Delivery

Drop / Collection  
Boxes

Chimes

Postal Accessories,  
Locks and Parts



## Excellent Design Fits In!

Vario™, the first turnkey, fully customizable 4C configurable mail shelter kit, originated from the desire for more architecturally pleasing design options for the USPS preferred method of centralized mail delivery. By adding your own roofing and siding materials, the vario™ allows design and building professionals the flexibility and opportunity to personalize the final product for full integration within the neighborhood and surrounding architecture. The pre-engineered shelter kit comes complete with Hilti anchors to secure the mail shelter to your existing concrete pad. Florence Manufacturing also makes it possible to create a true community gathering area, by providing additional site amenities and options. Built to the 2006 International Building Code Standards, the vario™ even offers an option to meet 150 mph wind resistance rating.



### Powder Coat Color Options

**Sandstone**  
PMS 7501C

**White**  
PMS White

**Dark Bronze**  
PMS Black 7C

**Forest Green**  
PMS 3308C

**Black**  
PMS Black 6C

**Silver Speck**  
PMS 877C

**Postal Grey**  
PMS 413C

VAR4B - back-to-back vario™ in black with Florence versatile™ 4C mailbox suites in silver speck and gable peak roof option

### Standard Features

- Shelter designed to meet the 2006 International Builders Code (IBC) for 90 mph or optional 150 mph wind resistance
- Shelter designed exclusively to accommodate USPS Approved Florence versatile™ 4C mailbox suite modules, but may also be used alone
- Shelters can be configured end-to-end, back-to-back, or back-to-back/end-to-end to create a larger bank of centralized mail stations
- Kit DOES NOT include finished roofing material or finishings for exterior end panels



**The First Turnkey, Fully Customizable Mail Shelter Kit!**

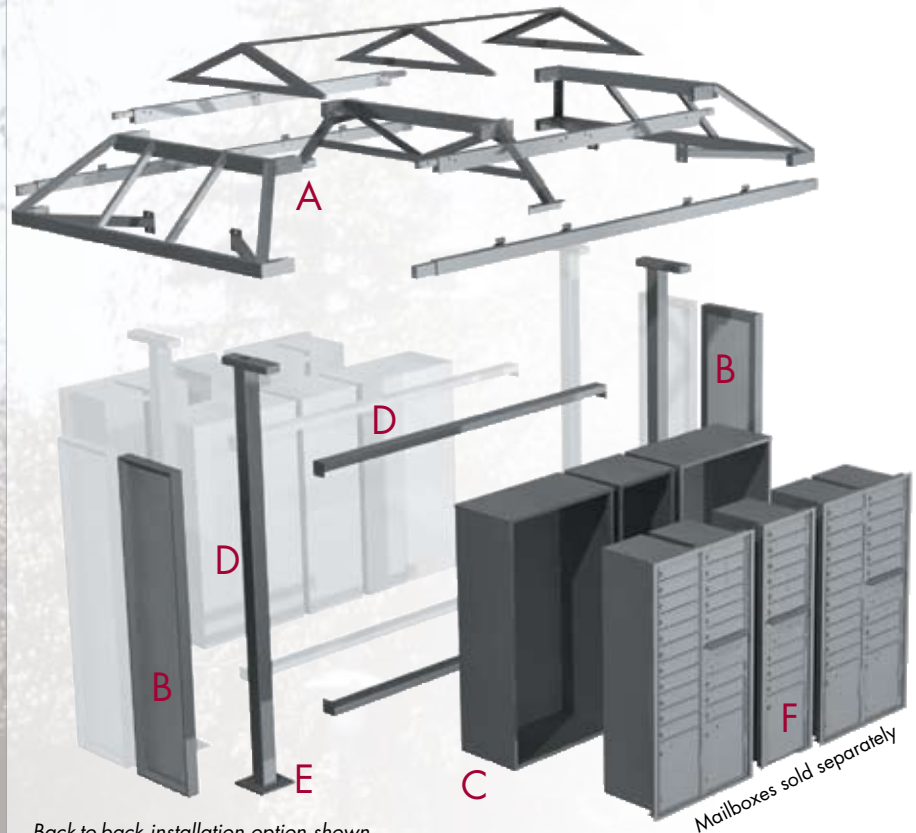

Back-to-back installation option shown installed behind standard layout with gable peak roof option

**Standard Kit Includes:**

- A. Welded aluminum roof sections (figure A) - Note: plywood and roofing finish not included in kit
- B. End panels (figure B) include pressure preserved plywood sheathing with coated interior (see color chart options on page 20) - Note: exterior finishing not included in kit
- C. Powder coat finished mailbox casings (figure C)
- D. Welded aluminum horizontal/vertical supports (figure D, E)
- E. All necessary hardware and stainless steel fasteners, including Hilti anchor system with epoxy and application gun - Note: concrete pad not included in kit - foundation plan available with quote or online at [auth-florence.com](http://auth-florence.com)
- F. versatile™ 4C mailbox suites sold separately (figure F)

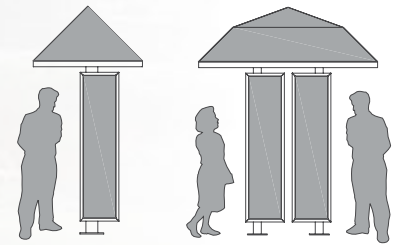

Standard and Back-to-back side views to show scale



Purchased without mailbox casings, your vario™ can serve as a shelter for CBU installations or other outdoor site solutions

USPS Approved  
New Construction

Mail Shelters and  
Site Amenities

USPS Approved

USPS Approved  
for Replacement

Private Delivery

Drop / Collection  
Boxes

Chimes

Postal Accessories,  
Locks and Parts





vario™ I

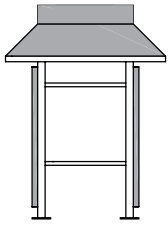

**VAR1**  
Standard with  
Gable Peak Roof

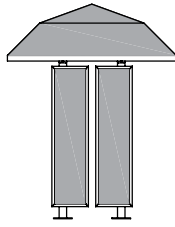

**VAR1B**  
Back-to-Back Side View  
with Gable Peak Roof

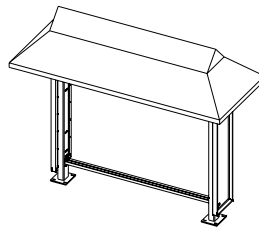

vario™ Standard  
Mailboxes on One Side

vario™ mail shelters are offered in a multitude of pre-engineered configurations to meet any residential or commercial development need. Below are definitions of the various shelter configurations available:

- **Standard**  
Mailboxes mounted on one side
- **Back-To-Back (B)**  
Mailboxes mounted on two sides
- **End-To-End (E)**  
(2) standard shelters joined together
- **Back-To-Back/End-To-End (BE)**  
(2) Back-To-Back shelters joined together
- **Optional Mid-Section (O)**  
Extends an E or BE installation by adding additional middle connectors

vario™ II

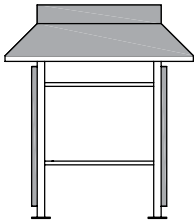

**VAR2**  
Standard with  
Gable Peak Roof

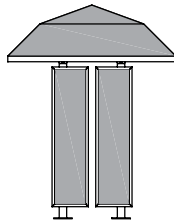

**VAR2B**  
Back-to-Back Side View  
with Gable Peak Roof

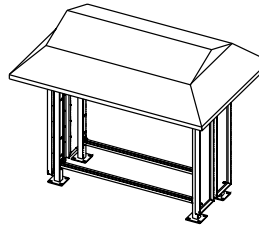

vario™ Back-to-Back  
Mailboxes on Both Sides

For more detailed dimensional information on ALL vario™ mail shelter kits, pad specification information, or additional product information, visit our website at [auth-florence.com](http://auth-florence.com)

vario™ III

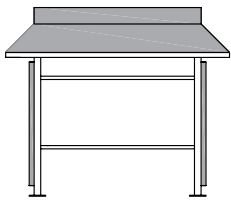

**VAR3**  
Standard with  
Gable Peak Roof

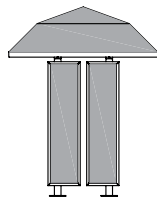

**VAR3B**  
Back-to-Back Side View  
with Gable Peak Roof

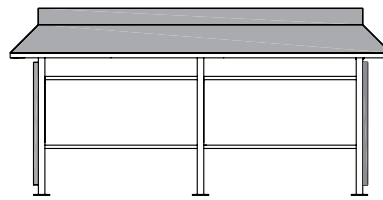

**VAR3E** (End-to-End) or  
**VAR3BE** (Back-to-Back/End-to-End)  
with Gable Peak Roof

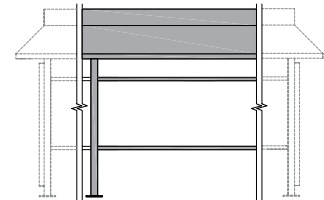

**VAR3E(O)** End-to-End or  
**VAR3BE(O)** Back-to-Back/  
End-to-End Mid-Section

vario™ IV

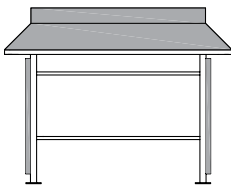

**VAR4**  
Standard with  
Gable Peak Roof

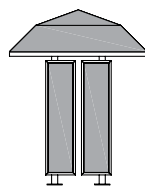

**VAR4B**  
Back-to-Back Side View  
with Gable Peak Roof

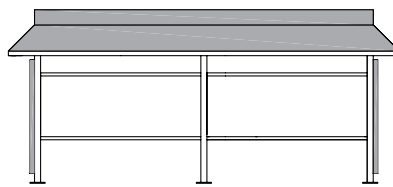

**VAR4E** (End-to-End) or  
**VAR4BE** (Back-to-Back/End-to-End)  
with Gable Peak Roof

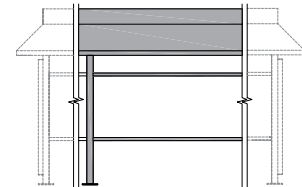

**VAR4E(O)** End-to-End or  
**VAR4BE(O)** Back-to-Back/  
End-to-End Mid-Section

vario™ Skylight Roof Option (Available Soon)

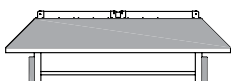

Front View

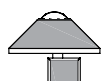

Standard  
Side View

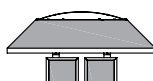

Back-to-Back  
Side View

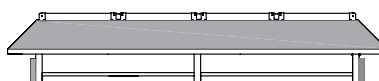

End-to-End Front View

# vario™ Dimensional Chart

MAXIMUM NUMBER OF TENANT MAILBOXES AND PARCEL BOXES		SUITE A		SUITE C		SUITE E		SUITE F		SUITE G	
ITEM#	SHELTER MODEL	MAILBOXES	PARCELS	MAILBOXES	PARCELS	MAILBOXES	PARCELS	MAILBOXES	PARCELS	MAILBOXES	PARCELS
VAR1	Vario I Standard (mailboxes one side)	15	1	16	2	9	1	20	2	19	2
VAR1B	Vario I Back-to-Back (mailboxes both sides)	28	2	32	4	18	2	40	4	38	4
VAR2	Vario II Standard	19	2	23	3	14	1	29	3	28	3
VAR2B	Vario II Back-to-Back	38	4	46	6	28	2	58	6	56	6
VAR3	Vario III Standard	34	3	39	5	23	2	49	5	47	5
VAR3B	Vario III Back-to-Back	68	6	78	10	46	4	98	10	94	10
VAR3E	Vario III End-to-End (2-sections/mailboxes one side)	68	6	78	10	46	4	98	10	94	10
VAR3E(O)	Vario III Mid-Section End-to-End (mailboxes one side)	34	3	39	5	23	2	49	5	47	5
VAR3BE	Vario III End-to-End/Back-to-Back (2-sections/mailboxes both sides)	132	13	156	20	84	8	196	20	188	20
VAR3BE(O)	Vario III Mid-Section End-to-End/Back-to-Back (mailboxes both sides)	68	6	78	10	46	4	98	10	94	10
VAR4	Vario IV Standard	38	4	48	6	27	3	60	6	57	6
VAR4B	Vario IV Back-to-Back	76	8	96	12	54	6	120	12	114	12
VAR4E	Vario IV End-to-End (2-sections/mailboxes one side)	76	8	96	12	54	6	120	12	114	12
VAR4E(O)	Vario IV Mid-Section End-to-End (mailboxes one side)	38	4	48	6	27	3	60	6	57	6
VAR4BE	Vario IV End-to-End/Back-to-Back (2-sections/mailboxes both sides)	152	16	192	24	108	12	240	24	228	24
VAR4BE(O)	Vario IV Mid-Section End-to-End/Back-to-Back (mailboxes both sides)	76	8	96	12	54	6	120	12	114	12

The chart above will help you select the shelter size and versatile™ 4C suite modules to best fit your individual project needs. Calculations are based on U.S. Postal Service STD-4C requirement of one (1) parcel locker per ten (10) mailboxes. This ratio may not apply if alternate package delivery arrangements exist at facility. Discuss with local USPS official for questions related to new mailbox delivery system.

## Shelter Size and Configuration

Maximums listed above are based on the largest casing configuration of double/single mailbox modules that fit into each type of shelter. Refer to the casing images below to make your versatile™ 4C mailbox module selection. Back-to-back shelters may utilize a different casing configuration on each side of the shelter. Due to casing trim, two single-column modules may not be substituted for a double-column module, except in the casing options shown below.

vario™ I ..... vario™ II .....

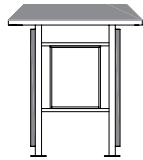

1 Double-Column

- or -



2 Single-Column

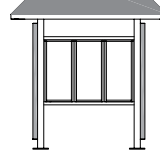

3 Single-Column

- or -

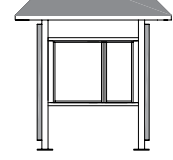

1 Double-Column,  
1 Single-Column

vario™ III .....

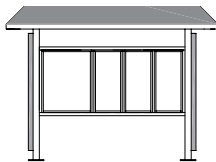

1 Double-Column,  
3 Single-Column

- or -

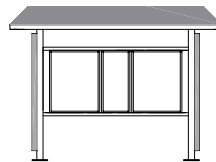

2 Double-Column,  
1 Single-Column

vario™ IV .....

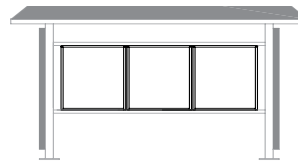

3 Double-Column

- or -

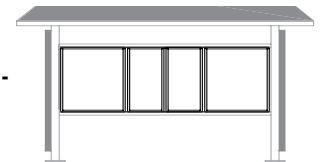

2 Double-Column,  
2 Single-Column

## Online Configurator

Florence Manufacturing also provides a one-of-a-kind online mailbox configurator to take the guess work out of doing it yourself. Simply visit [auth-florence.com/cad](http://auth-florence.com/cad) to be guided step-by-step through the product selection process for your vario™ mail shelter kit. Once you've selected all the appropriate options, you can submit a quote request directly to your local Authorized Florence Dealer. This tool is available day or night and can assist you not only with the pre-engineered shelter kit, but with your Florence versatile™ 4C mailbox suite selection as well.

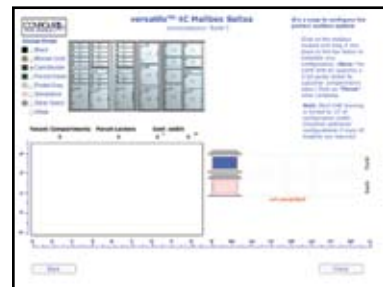

## vario™ mail shelter options

Additional options are available to enhance and strengthen your vario™ mail shelter. The ability to personalize your mail shelter further enables it to blend in with the surrounding architecture, creating a beautiful environment which promotes community gathering.



### Interior Side Panel Color Options

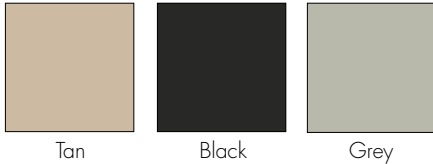

Tan

Black

Grey

This interior protective coating will enhance the look and life of your vario™ mail shelter and is available in three color options. (Exterior finishing choices are up to you.) This plywood is pressure preserved in accordance with AWPAC9 for extended life performance and makes an excellent mounting surface for your selected finishings.

### LED Lights



Solar or A/C Compatible Kits Available

Enhance your vario™ mail shelter with a lighting option that suits your installation. Sold separately, the LED lighting is designed for integration into the shelter roof design and is activated by heat-detecting motion sensors. Light strips may be either hard wired with the included A/C compatible kit or designed to stand alone with the solar kit option.

### Roof Styles

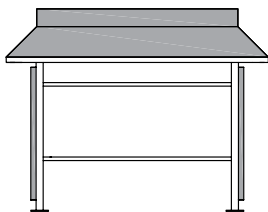

Gable Peak Roof

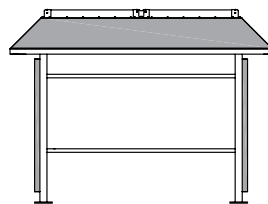
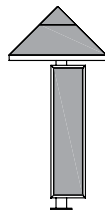
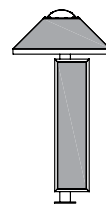
Skylight Roof  
(Available Soon)

Designed to fit with the surrounding architecture, the roof of the vario™ mail shelter will support your selected custom finishing materials, from asphalt shingles to tile, which you add on-site to either the gable peak or solar light roof options.

### Wind Resistance Rating

1. 90 mph = Standard Package
2. 150 mph = Hurricane Package

The vario™ mail shelters are designed and built to meet 2006 International Building Code (IBC) Standards, withstanding a three-second gust of either 90 mph or 150 mph winds depending on shelter package selected. As some geographic areas have local building codes requiring higher levels of wind resistance, check with local building officials before finalizing selection.



## NEW Outdoor Public Space Site Solutions

Florence Manufacturing is pleased to offer additional mail station accessories such as solar lights, benches, receptacles, planters and bike racks to help you create a safe, cohesive community gathering area around your mail delivery center. Whether you are simply adding amenities to existing installations, or are creating a complete mail station, we have the solution for you. Our products utilize efficient use of space which will help you develop harmony between your resident's needs and the surrounding environment. The sentinel™ solar site lite comes in either surface or in-ground mounting options and has either a 2' or 5' riser option. Available in three weather-resistant powder coat color options, the sentinel™ is the perfect addition to all your pedestrian settings.

### sentinel™ solar site lite

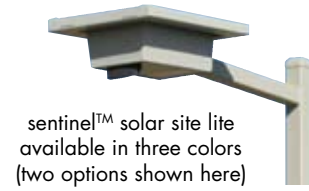

sentinel™ solar site lite available in three colors (two options shown here)



## Florence Site Furnishings



VSFBNCH Traditional High Back Bench  
*(patent pending)*



VSFBCH Contemporary Flat Bench  
*(patent pending)*



VSFBIKE Bike Rack



VSFLR36 Litter Receptacle  
(VSFLR24 not shown)



VSFPLNT Planter



VSFAURN Ash Urn



-Manufacturers of Quality Site Furnishings since 1962-



## NEW Design to Meet Changing Needs

Once again Florence Manufacturing has partnered with the USPS to provide a superior product which meets your ever increasing security and parcel delivery needs. The redesigned valiant™ 1590 series meets all the "F" CBU security standards set by the USPS and is part of the outdoor delivery equipment contract awarded solely to Florence Manufacturing. As the exclusive provider of the **NEW** Outdoor Parcel Locker to the USPS, Florence is pleased to bring you yet another product they depend upon every day!



1590T1SDAF in standard sandstone finish

**NEW**

**Powder Coat Color Options**

Standard:

**Sandstone**  
PMS 7501C

Optional:

**White**  
PMS White

**Silver Speck**  
PMS 877C

**Forest Green**  
PMS 3308C

**Black**  
PMS Black 6C

**Dark Bronze**  
PMS Black 7C

Replacement:

**Postal Grey**  
PMS 413C

**Lock Type**



The 1590 OPL series comes standard with a K91910 double cam lock

K91910

**Standard Features**

- Robotically welded cabinet and hood seams
- Rugged, weather resistant powder coat finish resists scratching and vandalism
- Constructed of 300 series stainless steel and aircraft aluminum, including aluminum pedestal
- Master front-loading door designed to prevent prying with interlocking overlap seams
- Silver adhesive metal placards with black numbers 1P-2P
- Overall dimensions: 16" W x 62" H x 18" D
- Compartment dimensions: 12" W x 19-3/4" H x 15" D
- Patent pending parcel locking mechanism

**ID Options**

- 1P-99P parcel locker placards
- Engraved numbers/letters

## Where Safe Mail Calls Home

Mail security isn't just for apartment buildings; it's for every mailbox in America. That's why Florence Manufacturing offers secure mail solutions for every mail application, including single family residential.

Florence residential products are weatherproof to protect delivered and outgoing mail from the elements. But unlike other boxes, Florence mail receptacles are fabricated with treated aluminum that resist rust and other signs of weathering to protect your investment as well as your mail. Plus, Florence residential mailboxes are large enough to secure up to two-weeks worth of normal mail delivery.



MB2000 box shown with MB2001P stand in standard silver speck

### Powder Coat Color Options

Standard:

**Silver Speck**  
PMS 877C

Optional:

**White**  
PMS White

**Sandstone**  
PMS 7501C

**Forest Green**  
PMS 3308C

**Black**  
PMS Black 6C

**Dark Bronze**  
PMS Black 7C

**Postal Grey**  
PMS 413C

### Standard Features

- Rugged, weather resistant powder coat finish resists scratching and vandalism
- Angled incoming mail slot deters theft
- Convenient outgoing mail shelf
- Large storage capacity can handle several days' mail

### Optional Features

- Curbside/Post installation
- Unique spreader plate designed to accommodate multiple boxes
- Seven powder coat color options

### USPS Standards for Placement

- 42-48" from road surface to point of mail entry
- 6-8" from front face of curb to mailbox door

### Lock Type

The MB2000 residential mailbox series comes standard with a 200116 lock.



200116

### MB2000 Models

MB2000.....	Curbside MB
MB2001P.....	MB post (in ground)
MB2001S.....	MB stand (surface)
755005SP.....	3" square MB post (in ground)
755004SP.....	3" square MB stand (surface)
756202S*.....	2-wide spreader plate
756203S*.....	3-wide spreader plate
756204S*.....	4-wide spreader plate

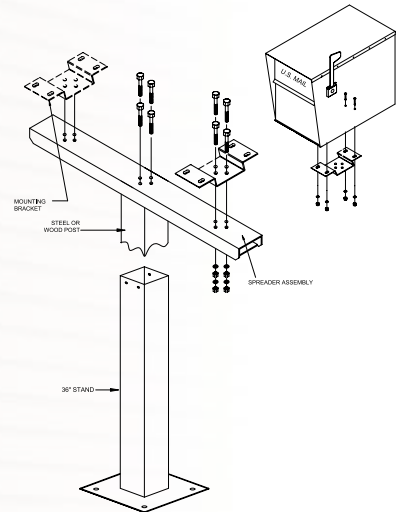

\* Spreader must be used with 3" square post or stand

Note: Users of the MB2000 are required to contact their local postal officials before installing the mailbox to ensure its correct placement.

### Did you know?

Florence Manufacturing maintains many products in stock so they can be shipped within 48 hours. Contact your local Authorized Dealer for details.





## Meeting Postal Regulations Made Easy

Changing postal standards can raise a lot of questions for anyone who deals with apartment mailboxes. The dilemma for property managers is whether to install Security Upgrade Kits (also available from Florence Manufacturing) in existing mailbox units to comply with STD-4B+, to get new mailbox units in compliance with STD-4B+, or to upgrade mailboxes to STD-4C. How do you decide? One easy way is to ask your local postal carrier. They may have recommendations to improve the security and convenience of your mail—a benefit to property managers, residents and the Postal Service alike. It's always a good idea to get the approval of your local postal authority before altering the mail system in your building. That way you can ensure that secure and convenient mail delivery is not interrupted for your residents.

USPS  
APPROVED  
REPLACEMENT  
PRODUCT



140075HSA (front loading)

Powder Coat  
Color Options

Sandstone  
PMS 7501 C

Dark Bronze  
PMS Black 7C

Black  
PMS Black 6C

Silver Speck  
PMS 877C

Gold  
PMS 871 C

Postal Grey  
PMS 413C

### Standard Features

- Grouped in combinations of 5, 6, or 7 compartments high and 3, 4, or 5 compartments wide
- Anodized aluminum finish
- 5-pin cylinder cam lock with two keys and 1,000 key changes
- Clear plastic number slots
- Lift-off rear cover on 1500 Series
- 15" deep compartments
- Recess-mounted only

### Optional Features

- Surface-mounted, alphabetized directory
- Matching snap-on trim kit
- 5/8" high engraved numbers with or without black color fill
- Engraved tabs for number slots
- Hinged and locking rear cover
- Integrated parcel lockers
- Integrated mail collection boxes
- Seven door size options
- Six powder coat color options
- **NEW** 3-digit combination locks

*Note: Florence 1400/1500 horizontal series is for indoor use only, not rated for outdoor use*

**Did you know?**

As of October 6, 2006, USPS STD-4C compliant mailbox systems are **MANDATORY** on all new construction and major renovations. Mailboxes that are 4B+ compliant, such as the Florence 1400/1500 horizontal series, will only be considered USPS Approved if they are replacing existing mailboxes. Be sure to check with your local postal authority before undergoing any changes to your buildings mail system. Further details on the new mandatory regulation can be found on page 14.

**Lock Type Options**

Both the 1400 and 1500 horizontal series comes standard with a Hudson K30809 lock. Additional lock options or replacement locks are available, but not necessarily USPS Approved. Refer to page 31 for additional details.



K30809

**1400/1500 Door Options**

An integrated mail collection box and/or parcel locker may be included with your selected horizontal mailbox system. Simply select doors two-, three-, four-, or five-high for these additional optional features to be included in your completed mail system.

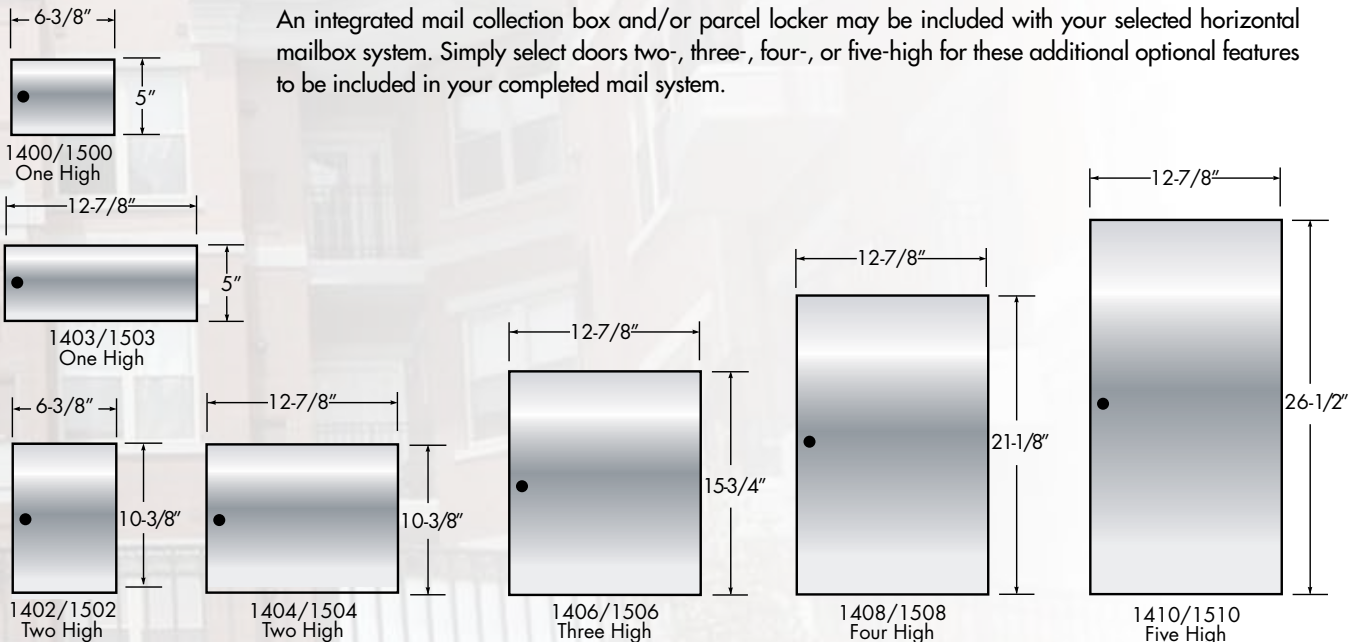

**Optional Horizontal Directories** (Smooth aluminum construction matches horizontal mailbox doors and powder coat color options)

**D400**

- Side-mount directory
- Designed to hold up to 200 names
  - D400-1 40 name capacity
  - D400-2 80 name capacity
  - D400-3 120 name capacity
  - D400-4 160 name capacity
  - D400-5 200 name capacity



**D500**

- Top-mount directory
- Available in 3, 4, or 5 units wide
- Designed to hold up to 40 names
  - D500-3 24 name capacity
  - D500-4 32 name capacity
  - D500-5 40 name capacity



**D600**

- Side-mount directory
- Available in 5, 6, or 7 units high
- Designed to hold up to 70 names
  - D600-5 50 name capacity
  - D600-6 60 name capacity
  - D600-7 70 name capacity



USPS Approved New Construction  
Mail Shelters and Site Amenities  
USPS Approved  
USPS Approved for Replacement  
Private Delivery  
Drop / Collection Boxes  
Chimes  
Postal Accessories, Locks and Parts

## 1400/1500 Series Dimension Chart

HEIGHT DIMENSION 5 UNITS HIGH Actual 2' 4", Rough* Opening 2' 4-1/4"			
Number of tenants		Model Number(s) and Quantities	Rough* Wall Opening Width
Front Load	Rear Load		
14	15	(1) 1500-53	1' 9"
19	20	(1) 1500-54	2' 3-1/2"
24	25	(1) 1500-55	2' 9-7/8"
38	40	(2) 1500-54	4' 6-3/4"
43	45	(1) 1500-54 (1) 1500-55	5' 1-1/8"
48	50	(2) 1500-55	5' 7-1/2"
62	65	(2) 1500-54 (1) 1500-55	7' 4-3/8"
72	75	(3) 1500-55	8' 5-1/8"
76	80	(4) 1500-54	9' 1-1/4"
81	85	(3) 1500-54 (1) 1500-55	9' 7-5/8"
91	95	(1) 1500-54 (3) 1500-55	10' 8-3/8"
96	100	(4) 1500-55	11' 2-3/4"
105	110	(3) 1500-54 (2) 1500-55	12' 5-1/4"
124	130	(4) 1500-54 (2) 1500-55	14' 8-1/2"
129	135	(3) 1500-54 (3) 1500-55	15' 2-7/8"
139	145	(1) 1500-54 (5) 1500-55	16' 3-5/8"
158	165	(2) 1500-54 (5) 1500-55	18' 6-7/8"
163	170	(1) 1500-54 (6) 1500-55	19' 1-1/4"
182	190	(2) 1500-54 (6) 1500-55	21' 4-1/2"
192	200	(8) 1500-55	22' 5-1/4"
196	205	(4) 1500-54 (5) 1500-55	23' 1-3/8"
211	220	(1) 1500-54 (8) 1500-55	24' 8-1/2"
216	225	(9) 1500-55	25' 2-7/8"

HEIGHT DIMENSION 6 UNITS HIGH Actual 2' 9-3/8", Rough* Opening 2' 9-5/8"			
17	18	(1) 1500-63	1' 9"
23	24	(1) 1500-64	2' 3-1/2"
29	30	(1) 1500-65	2' 9-7/8"
34	36	(2) 1500-63	3' 5-3/4"
46	48	(2) 1500-64	4' 6-3/4"
52	54	(1) 1500-64 (1) 1500-65	5' 1-1/8"
58	60	(2) 1500-65	5' 7-1/2"
63	66	(1) 1500-63 (2) 1500-64	6' 3-1/2"
69	72	(3) 1500-64	6' 10"
75	78	(2) 1500-64 (1) 1500-65	7' 4-3/8"
87	90	(3) 1500-65	8' 5-1/8"
92	96	(4) 1500-64	9' 1-1/4"
98	102	(3) 1500-64 (1) 1500-65	9' 7-5/8"
104	108	(2) 1500-64 (2) 1500-65	10' 2"
110	114	(1) 1500-64 (3) 1500-65	10' 8-3/8"
116	120	(4) 1500-65	11' 2-3/4"
133	138	(3) 1500-64 (3) 1500-65	12' 11-5/8"
139	144	(1) 1500-64 (4) 1500-65	13' 6"
145	150	(5) 1500-65	14' 0-3/8"
150	156	(4) 1500-64 (2) 1500-65	14' 8-1/2"
156	162	(3) 1500-64 (3) 1500-65	15' 2-7/8"
174	180	(6) 1500-65	16' 10"
185	192	(3) 1500-64 (4) 1500-65	18' 0-1/2"
191	198	(2) 1500-64 (5) 1500-65	18' 6-7/8"
197	204	(1) 1500-64 (6) 1500-65	19' 1-1/4"
214	222	(3) 1500-64 (5) 1500-65	20' 10-1/8"
220	228	(2) 1500-64 (6) 1500-65	21' 4-1/2"
226	234	(1) 1500-64 (7) 1500-65	21' 10-7/8"
232	240	(8) 1500-65	22' 5-1/4"
239	248	(4) 1500-64 (5) 1500-65	23' 1-3/8"
249	258	(2) 1500-64 (7) 1500-65	24' 2-1/8"
255	264	(1) 1500-64 (8) 1500-65	24' 8-1/2"
261	270	(9) 1500-65	25' 2-7/8"

HEIGHT DIMENSION 7 UNITS HIGH Actual 3' 2-3/4", Rough* Opening 3' 3"			
Number of tenants		Model Number(s) and Quantities	Rough* Wall Opening Width
Front Load	Rear Load		
20	21	(1) 1500-73	1' 9"
27	28	(1) 1500-74	2' 3-1/2"
34	35	(1) 1500-75	2' 9-7/8"
40	42	(2) 1500-73	3' 5-3/4"
47	49	(1) 1500-73 (1) 1500-74	4' 0-1/4"
54	56	(2) 1500-74	4' 6-3/4"
61	63	(1) 1500-74 (1) 1500-75	5' 1-1/8"
68	70	(2) 1500-75	5' 7-1/2"
74	77	(1) 1500-73 (2) 1500-74	6' 3-1/2"
81	84	(3) 1500-74	6' 10"
88	91	(2) 1500-74 (1) 1500-75	7' 4-3/8"
95	98	(1) 1500-74 (2) 1500-75	7' 10-3/4"
102	105	(3) 1500-75	8' 5-5/8"
108	112	(4) 1500-74	9' 1-1/4"
115	119	(3) 1500-74 (1) 1500-75	9' 7-5/8"
122	126	(2) 1500-74 (2) 1500-75	10' 2"
129	133	(1) 1500-74 (3) 1500-75	10' 8-3/8"
136	140	(4) 1500-75	11' 2-3/4"
142	147	(4) 1500-74 (1) 1500-75	11' 10-7/8"
149	154	(3) 1500-74 (2) 1500-75	12' 5-1/4"
156	161	(2) 1500-74 (3) 1500-75	12' 11-5/8"
163	168	(1) 1500-74 (4) 1500-75	13' 6"
170	175	(5) 1500-75	14' 0-3/8"
176	182	(4) 1500-74 (2) 1500-75	14' 8-1/2"
183	189	(3) 1500-74 (3) 1500-75	15' 2-7/8"
190	196	(2) 1500-74 (4) 1500-75	15' 9-1/4"
197	203	(1) 1500-74 (5) 1500-75	16' 3-5/8"
204	210	(6) 1500-75	16' 10"
210	217	(4) 1500-74 (3) 1500-75	17' 6-1/8"
217	224	(3) 1500-74 (4) 1500-75	18' 0-1/2"
224	231	(2) 1500-74 (5) 1500-75	18' 6-7/8"
231	238	(1) 1500-74 (6) 1500-75	19' 1-1/4"
238	245	(7) 1500-75	19' 7-5/8"
244	252	(4) 1500-74 (4) 1500-75	20' 3-3/4"
251	259	(3) 1500-74 (5) 1500-75	20' 10-1/8"
258	266	(2) 1500-74 (6) 1500-75	21' 4-1/2"
265	273	(1) 1500-74 (7) 1500-75	21' 10-7/8"
272	280	(8) 1500-75	22' 5-1/4"
278	287	(4) 1500-74 (5) 1500-75	23' 1-3/8"
285	294	(3) 1500-74 (6) 1500-75	23' 7-3/4"
292	301	(2) 1500-74 (7) 1500-75	24' 2-1/8"
299	308	(1) 1500-74 (8) 1500-75	24' 8-1/2"
306	315	(9) 1500-75	25' 2-7/8"

### Security Upgrade Kit

Installing a security upgrade kit improves lock strength and greater resistance to the most common methods of attack. Florence Manufacturing kits far exceed the current mailbox safety standards and are designed to harden both the Postal Arrow Lock and Master Gate Door. This USPS approved kit is easy to install, taking only a few tools and a little time.

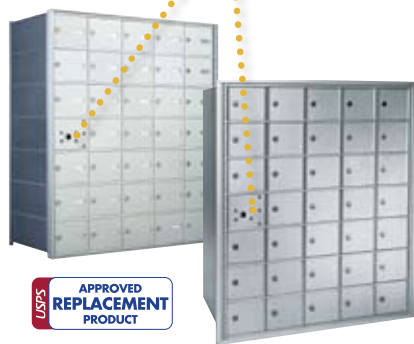
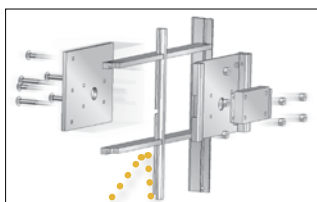

USPS APPROVED REPLACEMENT PRODUCT

### Installation

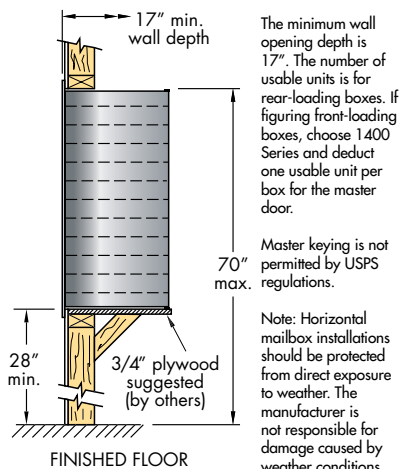

Above dimensions apply to both 1400 and 1500 series.

\*To figure the actual width, deduct 1/4" from the rough opening dimension.

\*Orders for non-standard mailbox configurations may not be accepted or may result in longer lead times.

### Did you know?

STD-4B+ was implemented in late 2004 and applies to apartment mailboxes. This USPS regulation requires improved Arrow lock compartment security on all horizontal and vertical wall-mounted mailboxes. In many cases, the STD-4B+ product designs include hardened Arrow lock bracketry and master gate doors as well as the removal of an outgoing mail slot.



## ID Options for Florence Mailbox Systems

Florence Manufacturing provides several different ID options for your replacement mailboxes. Simply select the option that best suits your project needs from the examples shown below.

Engraving



Black Fill Engraving



Clear Vision Window

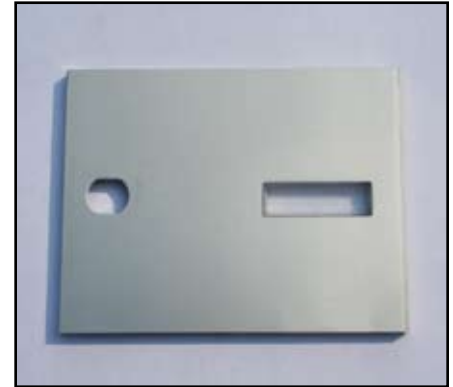

Metal Placards



Engraved ID Tag



Number Slot



Note: Not all ID Options are available on all products; see individual product pages for specific ID details.

### Standard Engraving

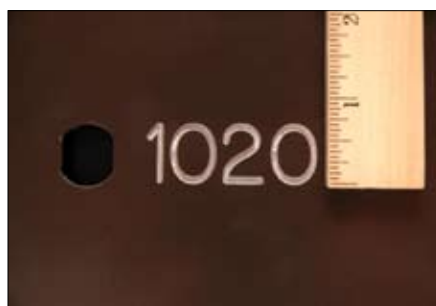

Florence Manufacturing utilizes the USPS Standard **US Block 1L** font for all engraving. This 5/8" high engraving may be created with or without black color fill and can contain up to six characters, depending upon door size. Custom engraving is available upon request.

Contact your local Authorized Florence Dealer or call 800-275-1747 for additional details and/or samples of the ID options shown above.



## A Name You Trust

Florence Manufacturing is pleased to continue to offer the 2600 American Device series of high security vault-type horizontal mailboxes designed especially for use in high crime and vandal prone areas. Boasting a unique three-point locking system (see image on facing page) and an interlocking feature on hinge-side of door, our American Device product line provides extra security if the hinge pin is tampered with. This line of horizontal boxes comes in both a front-loading with built-on trim (2600F-VT) option and rear-loading with snap-on trim (2600R-VT) option.



USPS  
**APPROVED  
REPLACEMENT  
PRODUCT**



2600F75HSA  
(front-loading)

### Standard Features

- Grouped in combinations of 5, 6, or 7 compartments high and 3, 4, or 5 compartments wide
- Anodized aluminum finish
- 5-pin cylinder cam lock with two keys and 1,000 key changes
- Clear plastic number slots
- Lift-off rear cover on 2600R Series
- 15" deep compartments
- Recess-mounted only
- Built-on trim (front-load only)

### Optional Features

- Surface-mounted, alphabetized directory
- Matching snap-on trim kit (rear-load only)
- 5/8" high engraved numbers with or without black color fill
- Engraved tabs for number slots
- Hinged and locking rear cover
- Integrated parcel lockers
- Integrated mail collection boxes
- Larger door sizes
- Six powder coat color options

*Note: Florence 2600 American Device horizontal series is for indoor use only, not rated for outdoor use*

Powder Coat  
Color Options

Sandstone  
PMS 7501C

Dark Bronze  
PMS Black 7C

Black  
PMS Black 6C

Silver Speck  
PMS 877C

Gold  
PMS 871C

Postal Grey  
PMS 413C

**Three-point Locking System**



K1111-114

**Lock Type Options**

The 2600 American Device horizontal series comes standard with a K1111-116 lock. Additional lock options or replacement locks are available, but not necessarily USPS Approved. Refer to page 31 for additional details.



K1111-116

**Florence 2600 American Device Horizontal Series Door Options**

An integrated mail collection box and/or parcel locker may be included with your selected horizontal mailbox system. Simply select doors two- or three-high for these additional optional features to be included in your completed mail system.

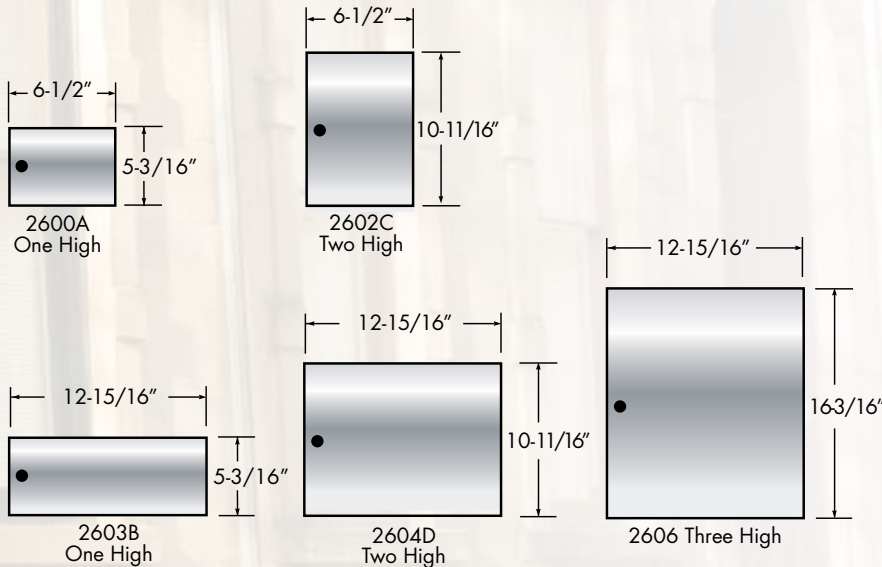

**Optional Integral Mail Collection Units**

**2162 Series**

2162 MAIL COLLECTION BOX MODELS	
Model Number	Number of Doors High
2162-1	1
2162-2	2
2162-3	3
2162-4	4



**Optional Horizontal Directory**

**D2600**

Top-mount directory for the Florence 2600 American Device horizontal mailbox series. Smooth aluminum construction matches horizontal mailbox doors and powder coat color options selected.



D2600-5A

**Did you know?**



As a dynamic company, Florence Manufacturing significantly expanded its product offering with the acquisition of the American Device Postal Specialties line in July 1998. A perfect complement to Florence postal specialties, American Device products have been known for their strength, security and long lasting durability.





# Florence 2600 American Device Horizontal Series Front-Loading Dimension Chart

5 UNITS HIGH	Height Dimensions, inches		With Integral Directory		6 UNITS HIGH	Height Dimensions, inches		With Integral Directory		7 UNITS HIGH	Height Dimensions, inches		With Integral Directory		Width Dimensions, Inches		
	Cabinet Net	Overall Trim	Rough Opening	28		29-3/4	36-5/8	33-1/2	35-1/4		42-1/8	39	40-3/4	47-5/8			
Number of Tenants*	Order Model Number	Arrangement and Number* of Compartments in Each Cabinet			Number of Tenants*	Order Model Number	Arrangement and Number* of Compartments in Each Cabinet			Number of Tenants*	Order Model Number	Arrangement and Number* of Compartments in Each Cabinet			Number of Postal Master Locks Required	Overall Trim Width	Rough Opening Width
14	2600F5-15	15			17	2600F6-18	18			20	2600F7-21	21			1	22-3/4	21-3/4
19	2600F5-20	20			23	2600F6-24	24			27	2600F7-28	28			1	29-1/4	28-1/4
24	2600F5-25	25			29	2600F6-30	30			34	2600F7-35	35			1	35-3/4	34-3/4
28	2600F5-30	15-15			34	2600F6-36	18-18			40	2600F7-42	21-21			2	45-1/2	44-1/2
33	2600F5-35	15-20			40	2600F6-42	18-24			47	2600F7-49	21-28			2	52	51
38	2600F5-40	20-20			46	2600F6-48	24-24			54	2600F7-56	28-28			2	58-1/2	57-1/2
43	2600F5-45	20-25			52	2600F6-54	24-30			61	2600F7-63	28-35			2	65	64
48	2600F5-50	25-25			58	2600F6-60	30-30			68	2600F7-70	35-35			2	71-1/2	70-1/2
52	2600F5-55	20-20-15			63	2600F6-66	24-24-18			74	2600F7-77	28-28-21			3	81-1/4	80-1/4
57	2600F5-60	20-20-20			69	2600F6-72	24-24-24			81	2600F7-84	28-28-28			3	87-3/4	86-3/4
62	2600F5-65	20-20-25			75	2600F6-78	24-24-30			88	2600F7-91	28-28-35			3	94-1/4	93-1/4
67	2600F5-70	20-25-25			81	2600F6-84	24-30-30			95	2600F7-98	28-35-35			3	100-3/4	99-3/4
72	2600F5-75	25-25-25			87	2600F6-90	30-30-30			102	2600F7-105	35-35-35			3	107-1/4	106-1/4
76	2600F5-80	20-20-20-20			92	2600F6-96	24-24-24-24			108	2600F7-112	28-28-28-28			4	117	116
81	2600F5-85	20-20-20-25			98	2600F6-102	24-24-24-30			115	2600F7-119	28-28-28-35			4	123-1/2	122-1/2
86	2600F5-90	20-20-25-25			104	2600F6-108	24-24-30-30			122	2600F7-126	28-28-35-35			4	130	129
91	2600F5-95	20-25-25-25			110	2600F6-114	24-30-30-30			129	2600F7-133	28-35-35-35			4	136-1/2	135-1/2
96	2600F5-100	25-25-25-25			116	2600F6-120	30-30-30-30			136	2600F7-140	35-35-35-35			4	143	142
100	2600F5-105	25-25-25-15-15			121	2600F6-126	24-24-24-24-30			142	2600F7-147	28-28-28-28-35			5	152-3/4	151-3/4
105	2600F5-110	25-25-25-20-15			127	2600F6-132	24-24-24-30-30			149	2600F7-154	28-28-28-35-35			5	159-1/4	158-1/4
110	2600F5-115	25-25-25-20-20			133	2600F6-138	24-24-30-30-30			156	2600F7-161	28-28-35-35-35			5	165-3/4	164-3/4
115	2600F5-120	25-25-25-25-20			139	2600F6-144	24-30-30-30-30			163	2600F7-168	28-35-35-35-35			5	172-1/4	171-1/4
120	2600F5-125	25-25-25-25-25			145	2600F6-150	30-30-30-30-30			170	2600F7-175	35-35-35-35-35			5	178-3/4	177-3/4
124	2600F5-130	25-25-25-25-15-15			150	2600F6-156	24-24-24-24-30-30			176	2600F7-182	28-28-28-28-35-35			6	188-1/2	187-1/2
129	2600F5-135	25-25-25-25-20-15			156	2600F6-162	24-24-24-30-30-30			183	2600F7-189	28-28-28-35-35-35			6	195	194
134	2600F5-140	25-25-25-25-20-20			162	2600F6-168	24-24-30-30-30-30			190	2600F7-196	28-28-35-35-35-35			6	201-1/2	200-1/2
139	2600F5-145	25-25-25-25-25-20			168	2600F6-174	24-30-30-30-30-30			197	2600F7-203	28-35-35-35-35-35			6	208	207
144	2600F5-150	25-25-25-25-25-25			174	2600F6-180	30-30-30-30-30-30			204	2600F7-210	35-35-35-35-35-35			6	214-1/2	213-1/2

Note: Horizontal mailbox installations should be protected from direct exposure to the weather; Florence Manufacturing is not responsible for damage caused by weather conditions. Orders for non-standard mailbox configurations may not be accepted, or may result in longer lead times.

## Company History



Florence Manufacturing is proud to trace its heritage of founding and acquired companies to the late 1800s. For more than a century, the Florence line of postal specialties has maintained industry leadership by offering consistently superior product quality and rapid, reliable customer service.

Our commitment to craftsmanship continues to be shown through not only being the first manufacturer in our industry to be ISO 9001:2000 certified, but that we continually surpass all required audits as well. We strive to be environmentally friendly with strong recycling programs and business practices and are pleased to be a committed community partner in our headquarters location of Manhattan, Kansas.

Founded by Saulia Florence and Herbert Dix in 1934 as Florence Manufacturing Company, we have continually strived to meet the changing market needs. As a dynamic, growing company, we acquired Auth Electric and started doing business as Auth-Florence Manufacturing in 1990. This hundred-year young company expanded our product offering to include Auth-Chimes – a quality product which has since been seen on the popular *Seinfeld* TV series. We significantly expanded our product offering once again with the acquisition of the American Device Postal Specialties line in July 1998. Two short years later, Florence Corporation acquired Cutler Manufacturing Corporation - a venerable century old company that had manufactured postal products for the likes of the Empire State Building and the John Hancock Building. Being awarded the USPS Outdoor Delivery Equipment contract in 2005 firmly solidified our position as a pillar of the industry. Florence Corporation further strengthened its market position with its recent acquisition by Gibraltar Industries (NASDAQ:ROCK).

Today, Florence Manufacturing continues to introduce new products to meet your mail delivery needs and we are looking to expand our product line once again with partnerships to provide outdoor site solutions. We are proud to have built relationships with the most extensive national dealer network in our industry - which enables us to provide you with local expertise in developing your specific mail center projects. To find an Authorized Florence Dealer nearest you, learn more about our extensive product lines or about our company, visit [auth-florence.com](http://auth-florence.com). To learn more about our new parent company, visit [gibraltar1.com](http://gibraltar1.com).

# Florence 2600 American Device Horizontal Series Rear-Loading Dimension Chart

5 UNITS HIGH			6 UNITS HIGH			7 UNITS HIGH			Width Dimensions, Inches		
Height Dimensions, inches			Height Dimensions, inches			Height Dimensions, inches					
Cabinet Net 28			Cabinet Net 33-1/2			Cabinet Net 39					
Overall Trim 31-3/4			Overall Trim 37-1/4			Overall Trim 42-3/4					
Rough Opening 29-1/2			Rough Opening 35			Rough Opening 40-1/2					
Number of Tenants	Order Model Number	Arrangement and Number of Compartments in Each Cabinet	Number of Tenants	Order Model Number	Arrangement and Number of Compartments in Each Cabinet	Number of Tenants	Order Model Number	Arrangement and Number of Compartments in Each Cabinet	Cabinet Net Width	Overall Trim Width	Rough Opening Width
15	2600R5-15	15	18	2600R6-18	18	21	2600R7-21	21	20	23-3/4	21-1/2
20	2600R5-20	20	24	2600R6-24	24	28	2600R7-28	28	26-1/2	30-1/4	28
25	2600R5-25	25	30	2600R6-30	30	35	2600R7-35	35	33	36-3/4	34-1/2
30	2600R5-30	15-15	36	2600R6-36	18-18	42	2600R7-42	21-21	40	43-3/4	41-1/2
35	2600R5-35	15-20	42	2600R6-42	18-24	49	2600R7-49	21-28	46-1/2	50-1/4	48
40	2600R5-40	20-20	48	2600R6-48	24-24	56	2600R7-56	28-28	53	56-3/4	54-1/2
45	2600R5-45	20-25	54	2600R6-54	24-30	63	2600R7-63	28-35	59-1/2	63-1/4	61
50	2600R5-50	25-25	60	2600R6-60	30-30	70	2600R7-70	35-35	66	69-3/4	67-1/2
55	2600R5-55	20-20-15	66	2600R6-66	24-24-18	77	2600R7-77	28-28-21	73	76-3/4	74-1/2
60	2600R5-60	20-20-20	72	2600R6-72	24-24-24	84	2600R7-84	28-28-28	79-1/2	83-1/4	81
65	2600R5-65	20-20-25	78	2600R6-78	24-24-30	91	2600R7-91	28-28-35	86	89-3/4	87-1/2
70	2600R5-70	20-25-25	84	2600R6-84	24-30-30	98	2600R7-98	28-35-35	92-1/2	96-1/4	94
75	2600R5-75	25-25-25	90	2600R6-90	30-30-30	105	2600R7-105	35-35-35	99	102-3/4	100-1/2
80	2600R5-80	20-20-20-20	96	2600R6-96	24-24-24-24	112	2600R7-112	28-28-28-28	106	109-3/4	107-1/2
85	2600R5-85	20-20-20-25	102	2600R6-102	24-24-24-30	119	2600R7-119	28-28-28-35	112-1/2	116-1/4	114
90	2600R5-90	20-20-25-25	108	2600R6-108	24-24-30-30	126	2600R7-126	28-28-35-35	119	122-3/4	120-1/2
95	2600R5-95	20-25-25-25	114	2600R6-114	24-30-30-30	133	2600R7-133	28-35-35-35	125-1/2	129-1/4	127
100	2600R5-100	25-25-25-25	120	2600R6-120	30-30-30-30	140	2600R7-140	35-35-35-35	132	135-3/4	133-1/2
105	2600R5-105	25-25-25-15-15	126	2600R6-126	24-24-24-24-30	147	2600R7-147	28-28-28-28-35	139	142-3/4	140-1/2
110	2600R5-110	25-25-25-20-15	132	2600R6-132	24-24-24-30-30	154	2600R7-154	28-28-28-35-35	145-1/2	149-1/4	147
115	2600R5-115	25-25-25-20-20	138	2600R6-138	24-24-30-30-30	161	2600R7-161	28-28-35-35-35	152	155-3/4	153-1/2
120	2600R5-120	25-25-25-25-20	144	2600R6-144	24-30-30-30-30	168	2600R7-168	28-35-35-35-35	158-1/2	162-1/4	160
125	2600R5-125	25-25-25-25-25	150	2600R6-150	30-30-30-30-30	175	2600R7-175	35-35-35-35-35	165	168-3/4	166-1/2
130	2600R5-130	25-25-25-25-15-15	156	2600R6-156	24-24-24-24-30-30	182	2600R7-182	28-28-28-28-35-35	172	175-3/4	173-1/2
135	2600R5-135	25-25-25-25-20-15	162	2600R6-162	24-24-24-30-30-30	189	2600R7-189	28-28-28-35-35-35	178-1/2	182-1/4	180
140	2600R5-140	25-25-25-25-20-20	168	2600R6-168	24-24-30-30-30-30	196	2600R7-196	28-28-35-35-35-35	185	188-3/4	186-1/2
145	2600R5-145	25-25-25-25-25-20	174	2600R6-174	24-30-30-30-30-30	203	2600R7-203	28-35-35-35-35-35	191-1/2	195-1/4	193
150	2600R5-150	25-25-25-25-25-25	180	2600R6-180	30-30-30-30-30-30	210	2600R7-210	35-35-35-35-35-35	198	201-3/4	199-1/2

## Horizontal Mailbox System Lock Type Options - Private Delivery

Florence Manufacturing is pleased to supply locks for your horizontal mailbox systems; however, in some cases the selected lock may change your mail system to a private delivery system. Be sure to check with your local postal authority for clarification and your local Authorized Florence Dealer for product details.

Graphite type lubricants only are recommended on all product locks. For additional assistance with locks, contact your local locksmith.

NEW

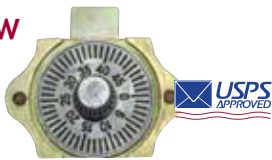

Part # 30815



Part # 30803 (lock)  
Part # 59801 (housing)  
(Florence only)



Part # 1111-114  
(American Device only)



Part # 30799

### lock suppliers

The following manufactured, customer-supplied locks (listed by cylinder number) are compatible with Florence mailboxes:

Arrow	AD615
Best	A7117
Falcon	6060,A11485,A11491,C982
Sargent	4101
Schlage	20-066,20-067,20-069
Weiser	11485,11491
Yale	C1810



## Traditionally Built

Florence 1250 vertical series mailboxes are designed for use in small, multi-family buildings. They are constructed of durable, heavy-gauge extruded aluminum. Doors and trim are striated to resist scratching. Mailboxes feature a fully-recessed mount, semi-recessed mount, or surface mount option to complement any installation. Designed to meet USPS STD-4B+, the Florence 1250 series has stronger compartment locks and master doors that better resist the more common methods of tampering. These boxes are ideal replacement options to ensure your residents continue to have safe and secure mail delivery options.



**APPROVED  
REPLACEMENT  
PRODUCT**

12505SMSA

### Standard Features

- Recessed (6-3/4"), Semi-recessed (3-3/4": Requires SR-120 collar) and Surface-mount (Requires SMS-125 collar) options available
- Door Size: 16" H x 5-1/2" W
- Compartment Size: 16-1/2" H x 5" W x 6" D
- Anodized aluminum or anodized gold standard finish
- 5-pin cylinder locks with two keys, 1,000 key changes
- Resident name and number ID card holders

### Powder Coat Color Options

Sandstone  
PMS 7501C

Dark Bronze  
PMS Black 7C

Black  
PMS Black 6C

Silver Speck  
PMS 877C

Gold  
PMS 871C

Postal Grey  
PMS 413C

### Did you know?

As of October 6, 2006, USPS STD-4C compliant mailbox systems are **MANDATORY** on all new construction and major renovations. Mailboxes that are 4B+ compliant, such as the Florence 1250 vertical series, will only be considered USPS Approved if they are replacing existing mailboxes. Be sure to check with your local postal authorities before undergoing any changes to your buildings mail system. This way you can ensure that secure and convenient mail delivery is not interrupted for you and your residents. Further details on the new mandatory STD-4C regulations can be found on page 14, by contacting your local Authorized Florence Dealer or by visiting [auth-florence.com](http://auth-florence.com).

### Optional Features

- 1255 series with integral 40 name directory
- Doorbell push buttons
- 1260 series with double wide door and optional outgoing mail slot
- Engraved doors
- Postal to private conversion kit
- Six powder coat color options

*Note: Florence 1250 vertical series is for indoor use only, not rated for outdoor use*



**Lock Type Options**

The 1250 vertical series comes standard with a Hudson K30809 lock.



**Optional Vertical Directory**



**D300**

- Designed for independent use or with vertical mailboxes
- Striated finish matches doors and trim of vertical mailboxes
- Designed to hold up to 200 names

Model #	Name Capacity
D300-1	40
D300-2	80
D300-3	120
D300-4	160
D300-5	200

Dimensions
19-1/8"H x 7-7/8"W
19-1/8"H x 13-5/16"W
19-1/8"H x 18-7/8"W
19-1/8"H x 24-3/8"W
19-1/8"H x 29-7/8"W

**1250SMS Series**

1250 series available in surface-mount option using SMS-125 collar or as a complete surface mount unit



**1255 Series**

1255 series available with optional integrated 40 name directory



**1260 Series**

1260 series available with double-wide door and optional outgoing mail slot



USPS Approved New Construction

Mail Shelters and Site Amenities

USPS Approved

USPS Approved for Replacement

Private Delivery

Drop / Collection Boxes

Chimes

Postal Accessories, Locks and Parts



# Vertical 1250 Series Dimension Charts

VERTICAL MAILBOXES WITH INTEGRAL DIRECTORY			
Model Number	Number of Directories	Number of Standard Compartments	Dimensions Same As
1255-13	1	3	12504H
1255-14	1	4	12505H
1255-15	1	5	12506H
1255-16	1	6	12507H
1255-23	2	3	12505H
1255-24	2	4	12506H
1255-25	2	5	12507H

VERTICAL MAILBOX WITH DOUBLE-WIDE OUTGOING MAIL SLOT			
Model Number	Number of Double-Wide Doors	Number of Standard Compartments	Dimensions Same As
1260-13	1	3	12505H
1260-14	1	4	12506H
1260-15	1	5	12507H
1260-21	2	1	12505H
1260-22	2	2	12506H
1260-23	2	3	12507H

VERTICAL MAILBOX WITH DOUBLE-WIDE OUTGOING MAIL SLOT				
Single Row	Double Row	Layout Per Row	Wall Cut Width	Overall Width
3	6	3	17-1/2"	19"
4	8	4	23"	24-1/2"
5	10	5	28-5/8"	30-1/8"
6	12	6	34-1/8"	35-5/8"
7	14	7	39-5/8"	41-1/8"
8	16	4-4	47-1/2"	49"
9	18	5-4	53-1/8"	54-5/8"
10	20	5-5	58-3/4"	60-1/4"
11	22	6-5	64-1/4"	65-3/4"
12	24	6-6	69-3/4"	71-1/4"
13	26	7-6	75-1/4"	76-3/4"
14	28	7-7	80-3/4"	82-1/4"
15	30	5-5-5	88-7/8"	90-3/8"
16	32	5-6-5	94-3/8"	95-7/8"
17	34	6-6-5	99-7/8"	101-3/8"
18	36	6-6-6	105-3/8"	106-7/8"
19	38	6-6-7	110-7/8"	112-3/8"
20	40	7-7-6	116-3/8"	117-7/8"
21	42	7-7-7	121-7/8"	123-3/8"
22	44	6-6-6-4	129-7/8"	131-3/8"
23	46	6-6-6-5	135-1/2"	137"
24	48	6-6-6-6	141"	142-1/2"
25	50	7-6-6-6	146-1/2"	148"
26	52	7-7-7-5	152"	153-1/2"
27	54	7-7-7-6	157-1/2"	159"
28	56	7-7-7-7	163"	164-1/2"
29	58	6-6-6-6-5	171-1/8"	172-5/8"
30	60	6-6-6-6-6	176-5/8"	178-1/8"

**Single Row**  
Wall Cut Depth = 6-3/4"  
Wall Cut Height = 17-3/4"  
Overall Height = 19-1/8"

**Double Row**  
Wall Cut Depth = 6-3/4"  
Wall Cut Height = 37"  
Overall Height = 39-1/4"

**Note:** Vertical mailbox installations should be protected from direct exposure to the weather. The manufacturer is not responsible for damage caused by weather conditions.

VERTICAL MAILBOX MODEL NUMBERS		
Number of Compartments	Standard Model Number	Surface Mount Model Number
3	12503H	12503SM5H
4	12504H	12504SM5H
5	12505H	12505SM5H
6	12506H	12506SM5H
7	12507H	12507SM5H

MOUNTING COLLAR MODEL NUMBERS		
Mailbox	Semi-Recess Mounted Collar	Surface Mounted Collar
12503H	SR1203	SMS1253
12504H	SR1204	SMS1254
12505H	SR1205	SMS1255
12506H	SR1206	SMS1256
12507H	SR1207	SMS1257

## Security Upgrade Kit

Florence security kits are USPS approved and contain sturdy components made from heavy gauge materials to strengthen your existing box against vandalism. Installation takes only minutes and a few tools, but provides years of tampering and theft protection.



## Installation

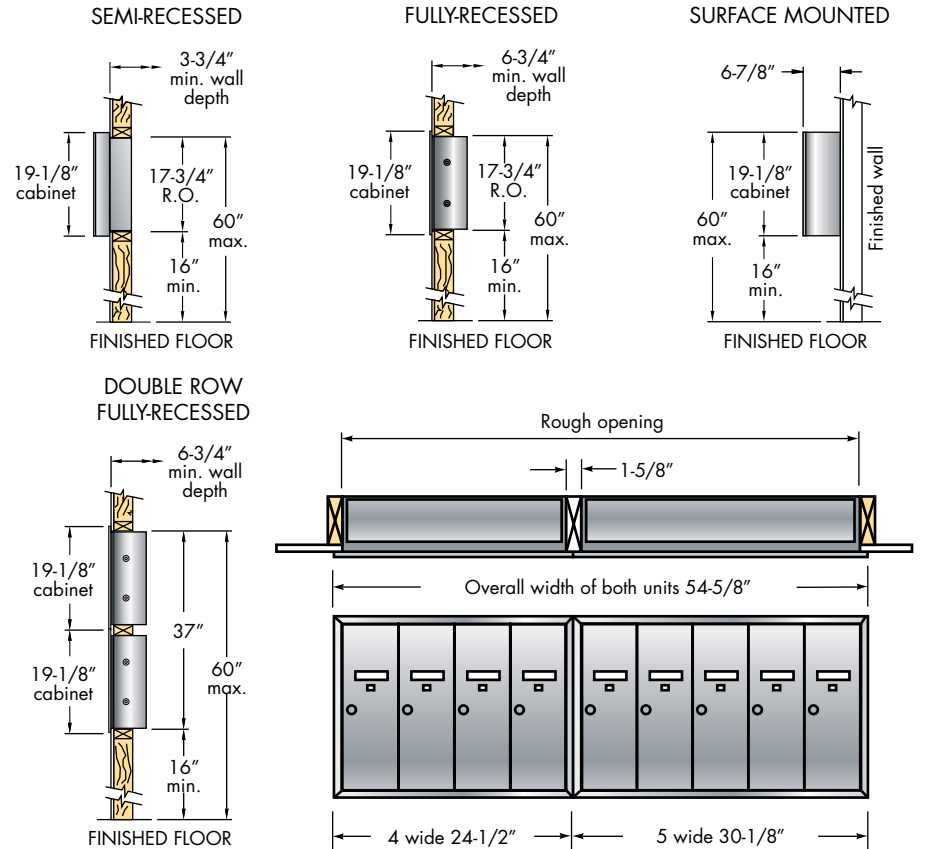

## Product Color Options

Note: Pantone colors shown in parentheses for reference purposes. Not all colors available on all products, see individual product pages for details.



Sandstone (PMS 7501C)  
- Flat or Pebble Finish -



Black (PMS Black 6C)  
- Flat or Pebble Finish -

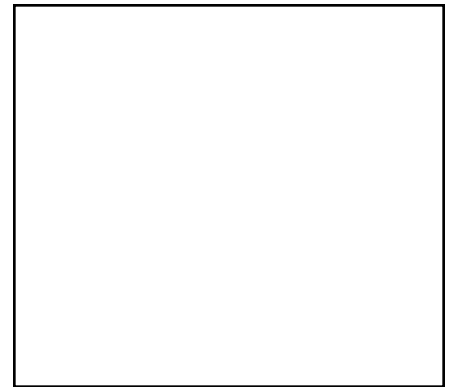

White (PMS White)  
- Flat or Pebble Finish -



Forest Green (PMS 3308C)  
- Flat or Pebble Finish -



Dark Bronze (PMS Black 7C)  
- Flat or Pebble Finish -

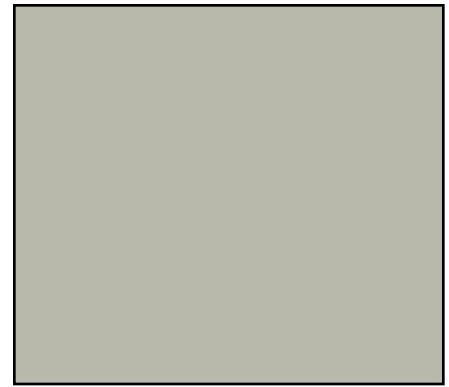

Postal Grey (PMS 413C)

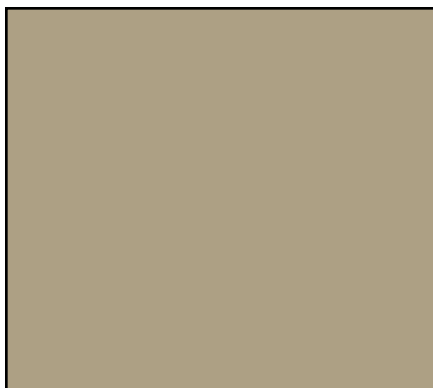

\*Blonde Gold (PMS 7536C)

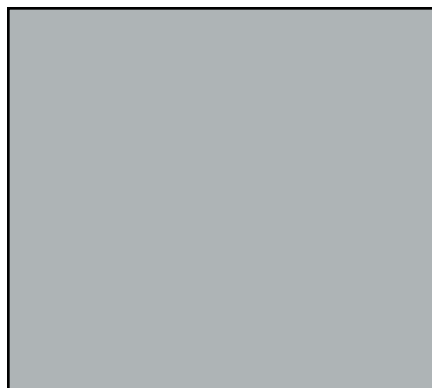

Silver Speck (PMS 877C)

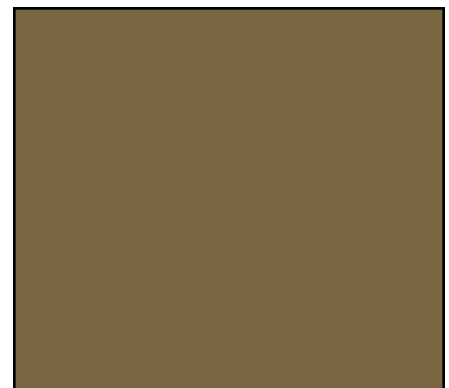

Gold (PMS 871C)

\*Blonde Gold and anodized metal finishes are not rated for outdoor use and are intended for inside installations only. All other powder coat paint color options available are weather-resistant and may be used for either indoor or outdoor installations. Paint chip samples are available by request.

### Metal Finishes:

\*Aluminum Anodized



\*Gold Anodized



USPS Approved  
New Construction

Mail Shelters and  
Site Amenities

USPS Approved

USPS Approved  
for Replacement

Private Delivery

Drop / Collection  
Boxes

Chimes

Postal Accessories,  
Locks and Parts





## Private Distribution is No Secret

It surprises some people that the USPS doesn't deliver directly to every mailbox in America. The concept of private distribution can seem even a bit strange; once delivered to a centralized location, it is distributed to individual resident mailboxes by a property manager or similar entrusted individual. Although a mystery to some, Florence Manufacturing understands the unique needs of residents who receive privately distributed mail. While certain needs such as keying and master access are different, other needs, like security, are the same. That is why we apply the expertise gained from our USPS partnership to these private distribution options - helping ensure all residents receive the same benefits.



### Powder Coat Color Options

Sandstone  
PMS 7501C

Dark Bronze  
PMS Black 7C

Black  
PMS Black 6C

Silver Speck  
PMS 877C

Gold  
PMS 871C

Postal Grey  
PMS 413C

### Standard Features

- Grouped in combinations of 9, 10, 11, or 12 compartments high and 3, 4, or 5 compartments wide
- 5-pin cylinder cam locks with two keys and 1,000 key changes
- Clear plastic number slots
- Private master lock on the 1450 Series
- 15" deep compartments
- Anodized aluminum finish

### Optional Features

- Snap-on trim kit
- **NEW** 3-digit combination locks
- 5/8" high engraved numbers with or without black fill numbers
- Engraved tabs for number slots
- Lift-off or locking rear cover available on 1550 series
- Seven door size options
- Six powder coat color options

*Note: Florence 1450/1550 horizontal series is for indoor use only, not rated for outdoor use*

1450/1550 Doors

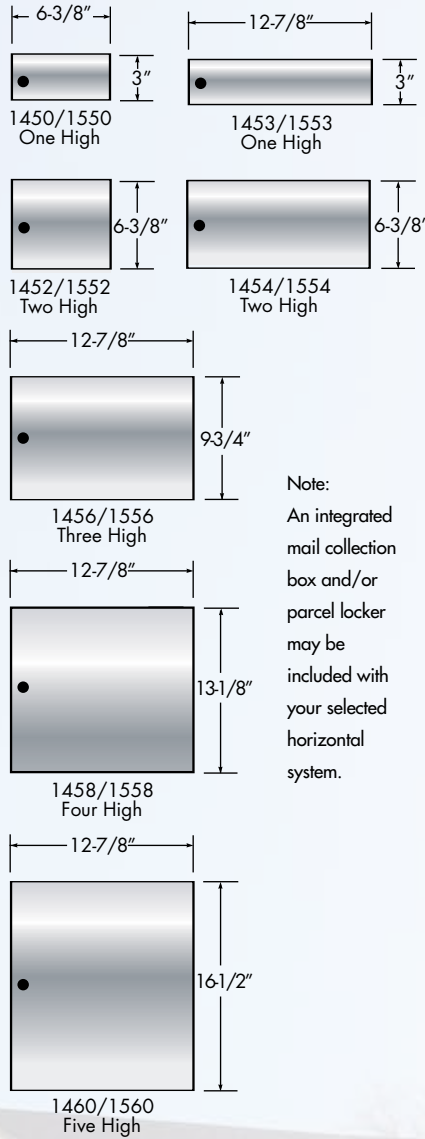

Note:  
An integrated mail collection box and/or parcel locker may be included with your selected horizontal system.

Installation

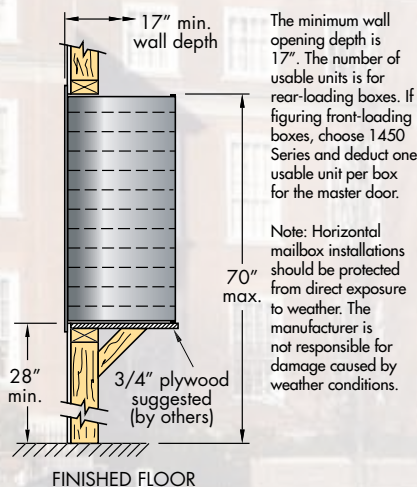

Lock Type Options

Both the 1450 and 1550 horizontal series comes standard with a Hudson K30809 lock. Additional lock options or replacement locks are available, but not necessarily USPS Approved. Refer to page 31 for additional details.



HEIGHT DIMENSION  
9 UNITS HIGH  
Actual 2' 7-1/2", Rough\* Opening 2' 7-3/4"

Number of tenants		Model Number(s) and Quantities	Rough* Wall Opening Width
Front Load	Rear Load		
26	27	(1) 1550-93	1' 9"
35	36	(1) 1500-94	2' 3-1/2"
44	45	(1) 1550-95	2' 9-7/8"
61	63	(1) 1550-93 (1) 1550-94	4' 0-1/4"
70	72	(2) 1550-94	4' 6-3/4"
79	81	(1) 1550-94 (1) 1550-95	5' 1-1/8"
88	90	(2) 1550-95	5' 7-1/2"
96	99	(1) 1550-93 (2) 1550-94	6' 3-1/2"
114	117	(2) 1550-94 (1) 1550-95	7' 4-3/8"
123	126	(1) 1550-94 (2) 1550-95	7' 10-3/4"
132	135	(3) 1550-95	8' 5-1/8"
140	144	(4) 1550-94	9' 1-1/4"
149	153	(3) 1550-94 (1) 1550-95	9' 7-5/8"
158	162	(2) 1550-94 (2) 1550-95	10' 2"
167	171	(1) 1550-94 (3) 1550-95	10' 8-3/8"
184	189	(4) 1550-94 (1) 1550-95	11' 10-7/8"
193	198	(3) 1550-94 (2) 1550-95	12' 5-1/4"
202	207	(2) 1550-94 (3) 1550-95	12' 11-5/8"
211	216	(1) 1550-94 (4) 1550-95	13' 6"
220	225	(5) 1550-95	14' 0-3/8"
228	234	(4) 1550-94 (2) 1550-95	14' 8-1/2"
237	243	(3) 1550-94 (3) 1550-95	15' 2-7/8"
246	252	(2) 1550-94 (4) 1550-95	15' 9-1/4"
255	261	(1) 1550-94 (5) 1550-95	16' 3-5/8"
264	270	(6) 1550-95	16' 10"

HEIGHT DIMENSION  
10 UNITS HIGH  
Actual 2' 10-7/8", Rough\* Opening 2' 11-1/8"

29	30	(1) 1550-103	1' 9"
39	40	(1) 1550-104	2' 3-1/2"
49	50	(1) 1550-105	2' 9-7/8"
68	70	(1) 1550-103 (1) 1550-104	4' 0-1/4"
78	80	(2) 1550-104	4' 6-3/4"
88	90	(1) 1550-104 (1) 1550-105	5' 1-1/8"
98	100	(2) 1550-105	5' 7-1/2"
117	120	(3) 1550-104	6' 10"
127	130	(2) 1550-104 (1) 1550-105	7' 4-3/4"
137	140	(1) 1550-104 (2) 1550-105	7' 10-3/4"
147	150	(3) 1550-105	8' 5-1/8"
156	160	(4) 1550-104	9' 1-1/4"
166	170	(3) 1550-104 (1) 1550-105	9' 7-5/8"
186	190	(1) 1550-104 (3) 1550-105	10' 8-3/8"
196	200	(4) 1550-105	11' 2-3/4"
205	210	(2) 1550-103 (3) 1550-105	11' 10-5/8"
225	230	(2) 1550-104 (3) 1550-105	12' 11-5/8"
245	250	(5) 1550-105	14' 0-3/8"
254	260	(2) 1550-103 (4) 1550-105	14' 8-1/4"
274	280	(2) 1550-104 (4) 1550-105	15' 9-1/4"
284	290	(1) 1550-104 (5) 1550-105	16' 3-5/8"

Above dimensions apply to both 1450 and 1550 series.

\*To figure the actual width, deduct 1/4" from the rough opening dimension.

\*Orders for non-standard mailbox configurations may not be accepted or may result in longer lead times.

HEIGHT DIMENSION  
11 UNITS HIGH  
Actual 3' 2-1/4", Rough\* Opening 3' 2-1/2"

Number of tenants		Model Number(s) and Quantities	Rough* Wall Opening Width
Front Load	Rear Load		
32	33	(1) 1550-113	1' 9"
43	44	(1) 1550-114	2' 3-1/2"
54	55	(1) 1550-115	2' 9-7/8"
64	66	(2) 1550-113	3' 5-3/4"
75	77	(1) 1550-113 (1) 1550-114	4' 0-1/4"
86	88	(2) 1550-114	4' 6-3/4"
97	99	(1) 1550-114 (1) 1550-115	5' 1-1/8"
108	110	(2) 1550-115	5' 7-1/2"
118	121	(1) 1550-113 (2) 1550-114	6' 3-1/2"
129	132	(3) 1550-114	6' 10"
140	143	(2) 1550-114 (1) 1550-115	7' 4-3/8"
151	154	(1) 1550-114 (2) 1550-115	7' 10-3/4"
162	165	(3) 1550-115	8' 5-1/8"
172	176	(4) 1550-114	9' 1-1/4"
183	187	(3) 1550-114 (1) 1550-115	9' 7-5/8"
194	198	(2) 1550-114 (2) 1550-115	10' 2"
205	209	(1) 1550-114 (3) 1550-115	10' 8-3/8"
216	220	(4) 1550-115	11' 2-3/4"
226	231	(2) 1550-113 (3) 1550-115	11' 10-5/8"
237	242	(3) 1550-114 (2) 1550-115	12' 5-1/4"
248	253	(2) 1550-114 (3) 1550-115	12' 11-5/8"
270	275	(5) 1550-115	14' 0-3/8"
280	286	(4) 1550-114 (2) 1550-115	14' 8-1/2"
291	297	(3) 1550-114 (3) 1550-115	15' 2-7/8"
302	308	(2) 1550-114 (4) 1550-115	15' 9-1/4"
313	319	(1) 1550-114 (5) 1550-115	16' 3-5/8"
324	330	(6) 1550-115	16' 10"

HEIGHT DIMENSION  
12 UNITS HIGH  
Actual 3' 5-5/8", Rough\* Opening 3' 5-7/8"

35	36	(1) 1550-123	1' 9"
47	48	(1) 1550-124	2' 3-1/2"
59	60	(1) 1550-125	2' 9-7/8"
82	84	(1) 1550-123 (1) 1550-124	4' 0-1/4"
94	96	(2) 1550-124	4' 6-3/4"
106	108	(1) 1550-124 (1) 1550-125	5' 1-1/8"
118	120	(2) 1550-125	5' 7-1/2"
141	144	(3) 1550-124	6' 10"
153	156	(2) 1550-124 (1) 1550-125	7' 4-3/8"
165	168	(1) 1550-124 (2) 1550-125	7' 10-3/4"
177	180	(3) 1550-125	8' 5-1/8"
188	192	(4) 1550-124	9' 1-1/4"
200	204	(3) 1550-124 (1) 1550-125	9' 7-5/8"
212	216	(2) 1550-124 (2) 1550-125	10' 2"
224	228	(1) 1550-124 (3) 1550-125	10' 8-3/8"
236	240	(4) 1550-125	11' 2-3/4"
247	252	(4) 1550-124 (1) 1550-125	11' 10-7/8"
259	264	(3) 1550-124 (2) 1550-125	12' 5-1/4"
271	276	(2) 1550-124 (3) 1550-125	12' 11-5/8"
283	288	(1) 1550-124 (4) 1550-125	13' 6"
295	300	(5) 1550-125	14' 0-3/8"
306	312	(4) 1550-124 (2) 1550-125	14' 8-1/2"
318	324	(3) 1550-124 (3) 1550-125	15' 2-7/8"
330	336	(2) 1550-124 (4) 1550-125	15' 9-1/4"
342	348	(1) 1550-124 (5) 1550-125	16' 3-5/8"
354	360	(6) 1550-125	16' 10"





## Make the Most of Your Mail Room

There are plenty of frustrating things about managing a university mail room, so getting the right mailbox unit shouldn't be one of them. That's why Florence Manufacturing allows you to custom configure your mailbox to fit your specific needs. Get the right number of resident boxes, parcel lockers and outgoing mail compartments to keep your students and faculty happy while still keeping your mail area organized and free of clutter. Available in both front- and rear- loading options, Florence Manufacturing solves all your private distribution mail needs.



### Standard Features

- Grouped in combinations of 7, 8, 9, or 10 compartments high and 3, 4, 5, or 6 compartments wide
- 5-pin cylinder cam lock with two keys
- Clear plastic number slots
- Private master lock on 1600 Series
- 5" high door
- 15" deep compartments
- Anodized aluminum finish
- Recess-mounted only
- Snap-on trim kit

### Optional Features

- **NEW** 3-digit combination lock
- 5-pin cylinder spring-latch lock
- 5/8" high engraved numbers with or without black fill numbers
- Engraved tabs for number slots
- Lift-off or hinged rear cover available for the 1700 series
- Eight door size options
- Six powder coat options

*Note: Florence 1600/1700 horizontal series is for indoor use only, not rated for outdoor use*

### Powder Coat Color Options

Sandstone  
PMS 7501C

Dark Bronze  
PMS Black 7C

Black  
PMS Black 6C

Silver Speck  
PMS 877C

Gold  
PMS 871C

Postal Grey  
PMS 413C

1600



1600/1700 Doors

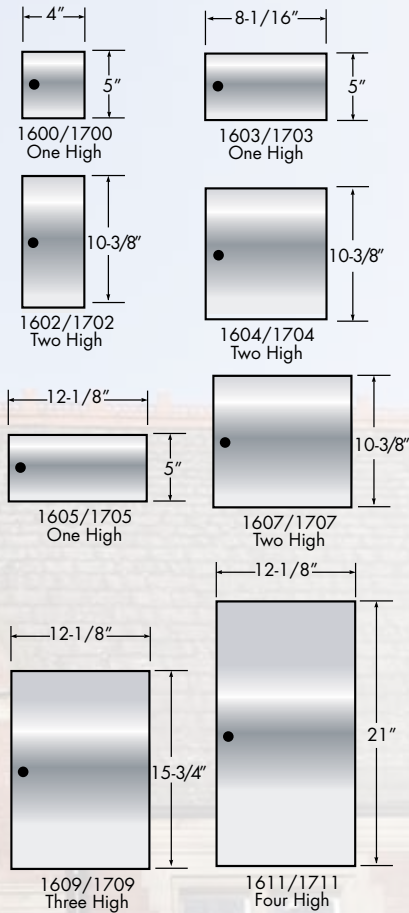

Note: An integrated mail collection box and/or parcel locker may be included with your selected vertical system.

Installation

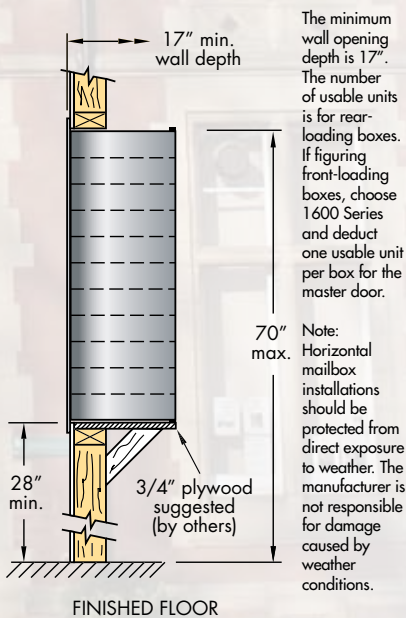

Lock Type Options

Both the 1600 and 1700 horizontal series comes standard with a Hudson K30809 lock. Additional lock options or replacement locks are available. Refer to page 31 for additional details.



HEIGHT DIMENSION 7 UNITS HIGH Actual 3' 2-3/4", Rough* Opening 3' 3"				
Number of tenants	Front Load	Rear Load	Model Number(s) and Quantities	Rough* Wall Opening Width
27	28	(1) 1700-74	1' 6-1/16"	
34	35	(1) 1700-75	1' 10-1/8"	
41	42	(1) 1700-76	2' 2-13/16"	
47	49	(1) 1700-73 (1) 1700-74	2' 7-13/16"	
54	56	(2) 1700-74	2' 11-7/8"	
61	63	(1) 1700-74 (1) 1700-75	3' 3-15/16"	
68	70	(2) 1700-75	3' 8"	
75	77	(1) 1700-75 (1) 1700-76	4' 0-1/16"	
82	84	(2) 1700-76	4' 4-1/8"	
88	91	(2) 1700-74 (1) 1700-75	4' 9-3/4"	
102	105	(3) 1700-75	5' 5-7/8"	
116	119	(2) 1700-76 (1) 1700-75	6' 2"	
129	133	(3) 1700-75 (1) 1700-74	6' 11-11/16"	
136	140	(4) 1700-75	7' 3-3/4"	
143	147	(3) 1700-75 (1) 1700-76	7' 7-13/16"	
150	154	(2) 1700-75 (2) 1700-76	9' 11-7/8"	
157	161	(3) 1700-76 (1) 1700-75	8' 3-15/16"	
164	168	(4) 1700-76	8' 8"	
177	182	(4) 1700-75 (1) 1700-76	9' 5-11/16"	
184	189	(3) 1700-75 (2) 1700-76	9' 9-3/4"	
191	196	(3) 1700-76 (2) 1700-75	10' 1-13/16"	
198	203	(4) 1700-76 (1) 1700-75	10' 5-7/8"	
205	210	(5) 1700-76	10' 9-15/16"	

HEIGHT DIMENSION 8 UNITS HIGH Actual 3' 8-1/8", Rough* Opening 3' 8-3/8"			
62	64	(2) 1700-84	2' 11-7/8"
70	72	(1) 1700-84 (1) 1700-85	3' 3-15/16"
78	80	(2) 1700-85	3' 8"
86	88	(1) 1700-85 (1) 1700-86	4' 0-1/16"
94	96	(2) 1700-86	4' 4-1/8"
101	104	(2) 1700-84 (1) 1700-85	4' 9-3/4"
109	112	(2) 1700-85 (1) 1700-84	5' 1-13/16"
117	120	(3) 1700-85	5' 5-7/8"
125	128	(2) 1700-85 (1) 1700-86	5' 9-15/16"
133	136	(2) 1700-86 (1) 1700-85	6' 2"
141	144	(3) 1700-86	6' 6-1/16"
148	152	(3) 1700-85 (1) 1700-84	6' 11-11/16"
156	160	(4) 1700-85	7' 3-3/4"
172	176	(2) 1700-85 (2) 1700-86	7' 11-7/8"
180	184	(3) 1700-86 (1) 1700-85	8' 3-15/16"
188	192	(4) 1700-86	8' 8"
203	208	(4) 1700-85 (1) 1700-86	9' 5-11/16"
211	216	(3) 1700-85 (2) 1700-86	9' 9-3/4"
219	224	(3) 1700-86 (2) 1700-85	10' 1-13/16"
227	232	(4) 1700-86 (1) 1700-85	10' 5-7/8"
242	248	(5) 1700-85 (1) 1700-86	11' 3-9/16"
250	256	(4) 1700-85 (2) 1700-86	11' 7-5/8"
258	264	(3) 1700-85 (3) 1700-86	11' 11-11/16"
266	272	(2) 1700-85 (4) 1700-86	12' 3-3/4"
274	280	(1) 1700-85 (5) 1700-86	12' 7-13/16"
282	288	(6) 1700-86	12' 11-7/8"

Above dimensions apply to both 1600 and 1700 series.  
\*To figure the actual width, deduct 1/4" from the rough opening dimension. Orders for non-standard mailbox configurations may not be accepted or may result in longer lead times.

HEIGHT DIMENSION 9 UNITS HIGH Actual 4' 1-1/2", Rough* Opening 4' 1-3/4"			
70	72	(2) 1700-94	2' 11-7/8"
79	81	(1) 1700-94 (1) 1700-95	3' 3-15/16"
88	90	(2) 1700-95	3' 8"
97	99	(1) 1700-95 (1) 1700-96	4' 0-1/16"
106	108	(2) 1700-96	4' 4-1/8"
114	117	(2) 1700-94 (1) 1700-95	4' 9-3/4"
123	126	(2) 1700-95 (1) 1700-94	5' 1-13/16"
132	135	(3) 1700-95	5' 5-7/8"
141	144	(2) 1700-95 (1) 1700-96	5' 9-15/16"
150	153	(2) 1700-96 (1) 1700-95	6' 2"
159	162	(3) 1700-96	6' 6-1/16"
167	171	(3) 1700-95 (1) 1700-94	6' 11-11/16"
185	189	(3) 1700-95 (1) 1700-96	7' 7-13/16"
194	198	(2) 1700-95 (2) 1700-96	7' 11-7/8"
203	207	(3) 1700-96 (1) 1700-95	8' 3-15/16"
212	216	(4) 1700-96	8' 8"
220	225	(5) 1700-95	9' 1-5/8"
229	234	(4) 1700-95 (1) 1700-96	9' 5-11/16"
238	243	(3) 1700-95 (2) 1700-96	9' 9-3/4"
247	252	(3) 1700-96 (2) 1700-95	10' 1-13/16"
256	261	(4) 1700-96 (1) 1700-95	10' 5-7/8"
265	270	(5) 1700-96	10' 9-15/16"

HEIGHT DIMENSION 10 UNITS HIGH Actual 4' 7", Rough* Opening 4' 7-1/4"			
68	70	(1) 1700-103 (1) 1700-104	2' 7-13/16"
78	80	(2) 1700-104	2' 11-7/8"
88	90	(1) 1700-104 (1) 1700-105	3' 3-15/16"
98	100	(2) 1700-105	3' 8"
108	110	(1) 1700-105 (1) 1700-106	4' 0-1/16"
118	120	(2) 1700-106	4' 4-1/8"
127	130	(2) 1700-104 (1) 1700-105	4' 9-3/4"
137	140	(2) 1700-105 (1) 1700-104	5' 1-13/16"
147	150	(3) 1700-105	5' 5-7/8"
157	160	(2) 1700-105 (1) 1700-106	5' 9-15/16"
167	170	(2) 1700-106 (1) 1700-105	6' 2"
177	180	(3) 1700-106	6' 6-1/16"
186	190	(3) 1700-105 (1) 1700-104	6' 11-11/16"
196	200	(4) 1700-105	7' 3-3/4"
206	210	(3) 1700-105 (1) 1700-106	7' 7-13/16"
216	220	(2) 1700-105 (2) 1700-106	7' 11-7/8"
226	230	(3) 1700-106 (1) 1700-105	8' 3-15/16"
236	240	(4) 1700-106	8' 8"
245	250	(5) 1700-105	9' 1-5/8"
255	260	(4) 1700-105 (1) 1700-106	9' 5-11/16"
265	270	(3) 1700-105 (2) 1700-106	9' 9-3/4"
275	280	(3) 1700-106 (2) 1700-105	10' 1-13/16"
285	290	(4) 1700-106 (1) 1700-105	10' 5-7/8"
295	300	(5) 1700-106	10' 9-15/16"
304	310	(5) 1700-105 (1) 1700-106	11' 3-9/16"
314	320	(4) 1700-105 (2) 1700-106	11' 7-5/8"
324	330	(3) 1700-105 (3) 1700-106	11' 11-11/16"
334	340	(2) 1700-105 (4) 1700-106	12' 3-3/4"
344	350	(1) 1700-105 (5) 1700-106	12' 7-13/16"
354	360	(6) 1700-106	12' 11-7/8"



### Reliability Every Step of the Way

Whether sending mail across town or across the country, it deserves protection from the beginning to the end of its journey. Just as resident compartments protect incoming mail, Florence Collection Boxes secure it while awaiting pick up by the USPS to help ensure safe mail right from the start. Florence Vertical Collection Boxes come in a choice of sizes for various installations to fit your individual project needs.

#### 12 Series



12RA

##### Standard Features

- 5/32" extruded aluminum door
- Extruded aluminum frame
- Steel compartment
- Anodized aluminum finish
- Letter slot 3/4" H x 5-3/4" W

##### Optional Features

- Engraved as specified
- Six powder coat color options
- Semi-recessed or surface-mount option available

##### Lock Features

- Private lock

#### 130 Series



130RA

##### Standard Features

- 5/32" extruded aluminum door
- Extruded aluminum frame
- Steel compartment
- Engraved "LETTERS"
- Anodized aluminum finish
- Letter slot 3/4" H x 10" W with deflector door

##### Optional Features

- Engraved as specified
- Six powder coat color options
- Semi-recessed or surface-mount

##### Lock Features

- Prepped for USPS lock - Standard
- Private lock available

#### 140 / 150 Series



150RA

##### Standard Features

- 5/32" extruded aluminum door
- Extruded aluminum frame
- Steel compartment
- Engraved "LETTERS"
- Anodized aluminum finish
- Letter slot 3/4" H x 10" W

##### Optional Features

- Engraved as specified
- Six powder coat color options
- Semi-recessed or surface-mount option available

##### Lock Features

- Prepped for USPS lock - Standard
- Private lock available

#### 120 Series



120SPSMS

##### Standard Features

- 5/32" extruded aluminum door
- Extruded aluminum frame
- Steel compartment
- Letter slot 3/4" H x 10" W
- Engraved "LETTERS"
- Anodized aluminum finish

##### Optional Features

- Engraved as specified
- Six powder coat color options
- Semi-recessed or surface-mount option available

##### Lock Features

- Prepped for USPS lock - Standard
- Private lock available

#### Powder Coat Color Options

Sandstone  
PMS 7501C

Dark Bronze  
PMS Black 7C

Black  
PMS Black 6C

Silver Speck  
PMS 877C

Gold  
PMS 871C

Postal Grey  
PMS 413C

Designed for integrated use with the Florence horizontal and vertical mailbox product lines, collection and drop boxes are a natural extension of your mailbox system.

For additional product details, contact your local Authorized Florence Dealer or visit us at [auth-florence.com](http://auth-florence.com).



**12/120/130/140/150 Dimensions**

Vertical collection boxes come in a choice of sizes for various installations and are constructed to be used in conjunction with most Florence vertical mailbox installations.

Category No.	USPS Approved	Rough Opening Height	Rough Opening Width	Frame Height	Frame Width	Rough Opening Depth
12R	No	17-5/8"	7-1/4"	19-1/8"	8-13/16"	6-3/4"
12SR	No	17-5/8"	7-1/4"	19-1/8"	8-13/16"	4-1/4"
12SM	No	—	—	19-1/8"	8-13/16"	—
12OR	No	17-5/8"	13-5/8"	19-1/8"	15-1/16"	6-3/4"
12OSR	No	17-5/8"	13-5/8"	19-1/8"	15-1/16"	4-1/4"
12OSM	No	—	—	19-1/8"	15-1/16"	—
12OSMP*	No	—	—	19-1/8"	15-1/16"	6-3/4"
13OR	Yes	22-1/4"	13-5/8"	23-5/8"	15-3/16"	6-3/4"
13OSR	Yes	22-1/4"	13-5/8"	23-5/8"	15-3/16"	4-1/2"
13OSM	Yes	—	—	23-5/8"	15-3/16"	—
140/150	No	17-3/8"	14-5/8"	19-7/8"	17-1/8"	17"

**\*120SMP**



120SMP also available with mail slot hood for protection against weather and optional pedestal – for private use only (Not USPS approved with these additional options).

**120SMLDL**



LD12 Series Letter Drop with Angled Wall Liner Chute to 120SM Collection Box provides security within a small space. (Also available with a straight chute)

**LD12A Letter Drop**



**Standard Features**

- Spring-hinged front door for door or wall installation
- Extruded aluminum construction
- Rough opening: 5" H x 12-5/8" W
- Frame size: 6-5/16" H x 14-1/16" W x 3/4" D
- Anodized aluminum finish
- Door size: 4" H x 11-3/4" W
- Engraved "U.S. MAIL"

**Optional Features**

- Engraved as specified
- LD12L wall liner available:
  - 8" standard unless otherwise specified
  - 4" to 12" available in full inch increments only
  - Specify straight or angled
- Can be used with 120SM Collection Box

USPS Approved  
New Construction

Mail Shelters and  
Site Amenities

USPS Approved

USPS Approved  
for Replacement

Private Delivery

Drop / Collection  
Boxes

Chimes

Postal Accessories,  
Locks and Parts





## The Value of Mail Collection

Meant for busy mail areas, a Florence Collection Bundle Box is a great way to add value and convenience to your building's mail system. As a large unit, a Collection Bundle Box can receive individual letters as well as bulkier, bundled metered mail. And with its heavy-gauge aluminum construction, even large volumes of mail are kept safe until picked up by the USPS. These units are designed for use alone, with Florence horizontal mailboxes, or can be sized to match the Florence 2600 American Device horizontal series; and are available in both front- and rear-loading options.



CCF60SMSA

### Standard Features

- Front loading (CCF series)
- Recess- (RM) or surface-mounted (SM)
- Master door and hopper door constructed of 1/4" aluminum
- 1-1/8" high engraved letters as shown
- Anodized aluminum finish

### Optional Features

- Rear-loading (CCR series)
- Prepared for postal lock on rear panel
- Engraving as specified
- Snap-on trim kit for recess-mounted model
- Six powder coat color options

MODEL NO.	DIMENSIONS
CCF36RM	20"W X 36"H X 17"D
CCF60RM	20"W X 60"H X 17"D
CCF36SM	20"W X 36"H X 17"D
CCF60SM	20"W X 60"H X 17"D
CCR36RM	20"W X 36"H X 17"D
CCR60RM	20"W X 60"H X 17"D

Note: Add 1/4" to all dimensions for rough opening when recess mounting

### Powder Coat Color Options

Sandstone  
PMS 7501 C

Dark Bronze  
PMS Black 7C

Black  
PMS Black 6C

Silver Speck  
PMS 877C

Gold  
PMS 871 C

Postal Grey  
PMS 413C

Collection Boxes



Standard Features

- Hopper door and master door constructed of 1/4" aluminum
- Master door 12-3/8" H x 15" W; Hopper door 8" H x 15" W; Handle 8-1/2" long
- Engraving standard as shown; characters 1-1/8" H
- Anodized aluminum finish

Optional Features

- Snap-on trim kit
- Engraving as specified
- Mail bag rack available
- Six powder coat color options
- Can be sized to match either Florence horizontal, 2600 American Device or 4C suite series

Lock Features

- Prepped for USPS lock - Standard
- Private lock available (front load only)

CC71FL

Book Depositories



CC11RL

Standard Features

- 1/4" thick extruded aluminum construction
- Rough opening: 11-1/4" H x 16-1/2" W
- Frame size 14" H x 19" W
- Hopper door size: 8" H x 15" W x 8-3/4" D
- Anodized aluminum finish
- Engraved "BOOK DEPOSITORY"

Optional Features

- Engraving as specified
- Six powder coat color options

MODEL NO.	ROUGH OPENING HEIGHT	FACE PLATE HEIGHT	ROUGH OPENING WIDTH	FACE PLATE WIDTH
CC51FL	25-5/8"	28"	18-1/4"	21"
CC52FL	25-5/8"	28"	35-1/4"	38"
CC53FL	25-5/8"	28"	52-1/4"	55"
CC51RL	25-1/4"	28"	18-1/4"	21"
CC52RL	25-1/4"	28"	35-1/4"	38"
CC53RL	25-1/4"	28"	52-1/4"	55"
CC61FL	25-5/8"	33-3/8"	18-1/4"	21"
CC62FL	25-5/8"	33-3/8"	35-1/4"	38"
CC63FL	25-5/8"	33-3/8"	52-1/4"	55"
CC61RL	30-5/8"	33-3/8"	18-1/4"	21"
CC62RL	30-5/8"	33-3/8"	35-1/4"	38"
CC63RL	30-5/8"	33-3/8"	52-1/4"	55"
CC71FL	25-5/8"	38-3/4"	18-1/4"	21"
CC72FL	25-5/8"	38-3/4"	35-1/4"	38"
CC73FL	25-5/8"	38-3/4"	52-1/4"	55"
CC71RL	36"	38-3/4"	18-1/4"	21"
CC72RL	36"	38-3/4"	35-1/4"	38"
CC73RL	36"	38-3/4"	52-1/4"	55"

USPS Approved  
New Construction

Mail Shelters and  
Site Amenities

USPS Approved

USPS Approved  
for Replacement

Private Delivery

Drop / Collection  
Boxes

Chimes

Postal Accessories,  
Locks and Parts



## Opportunity May Knock Only Once... But We Let It Chime, Year After Year

For over a hundred years, property owners have relied on Auth-Chimes for high-quality, maintenance-free door enhancements. Our time proven design, quality materials and acoustically buffered strike pads work harmoniously to create a rich and distinctive two-note musical tone that is always pleasant to the ear. Our models allow your residents to see out, while preventing unwanted visitors from seeing in. And, because our chimes are not dependent upon electricity, you never have to worry about power failures, worn batteries, or frayed wires. Florence Manufacturing continues this proud tradition of exceptional design, unmatched durability and affordable elegance; so don't open the door to just anyone, let us find the right chime for your specific application.



Chime Color Options

- Anodized Gold
- Anodized Silver
- Bronze
- Gold Powder Coat
- Silver Powder Coat
- Gold Chrome
- Silver Chrome

**NEW** Auth-Chimes Cover with spring-activated sliding viewer

### Did you know?

All viewing lenses and mirrors feature secure, one-way visibility with wide angle viewing designed to fit doors up to 4-3/4" thick. UL fire rated options are also available and are designed to fit doors up to 2-1/2" thick.

### Installation

A self-contained mechanical design allows all of our chimes to be easily installed with just a screwdriver and drill. Each unit comes complete with fastening hardware, positioning templates and easy-to-follow instructions. There are no wires, transformers, buzzer connections or electrical hook-ups to worry about, so forget the electrician. We are so confident of our product's performance, we offer a one-year warranty on all parts that cease to function due to normal wear and tear.

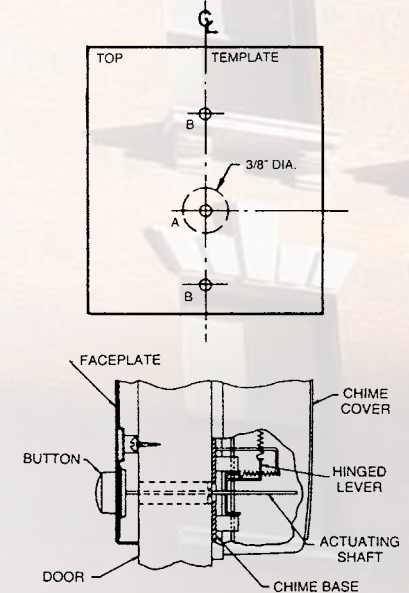



**Model 684**



**Features**

- 5" H x 2" W
- One-way viewing mirror designed to fit doors up to 4-3/4" thick
- Aluminum or bronze chime faceplate available
- Apartment identification plate
- Name plate

**Aluminum Finishes**

684101-01 - Anodized Silver  
684102-01 - Anodized Gold

**Bronze Finishes**

684104-01 - Bronze

**Model 685**



**Features**

- 5" H x 2" W
- One-way wide-angle viewing lens designed to fit doors up to 4-3/4" thick
- Aluminum or bronze chime faceplate available
- Engraving optional
- (UL) Fire-rated viewers optional

**Aluminum Finishes**

685101-01 - Anodized Silver  
685102-01 - Anodized Gold

**Bronze Finishes**

685104-01 - Bronze

**Model 686**



**Features**

- 5" H x 2" W
- One-way wide-angle viewing lens designed to fit doors up to 4-3/4" thick
- Aluminum or bronze chime faceplate available
- Apartment identification plate
- Name plate
- (UL) Fire-rated viewers optional

**Aluminum Finishes**

686101-01 - Anodized Silver  
686102-01 - Anodized Gold  
686105-01 - Silver Chrome  
686106-01 - Gold Chrome

**Bronze Finishes**

686104-01 - Bronze

**Model 687**



**Features**

- 2-1/4" H x 2" W
- Name plate

**Aluminum Finishes**

687101-01 - Anodized Silver  
687102-01 - Anodized Gold

**Model 689**



**Features**

- 6-5/8" H x 3" W
- Modern, deep recessed, deluxe one-way viewing mirror designed to fit doors up to 4-3/4" thick
- Engraving optional
- Apartment identification plate
- Name plate
- Heavy, cast metal with powder coat finish

**Aluminum Finishes**

689105-01 - Silver Powder Coat  
689106-01 - Gold Powder Coat

**Model 690**



**Features**

- Oval shaped
- Wide-angle (UL) fire-rated viewer designed to fit doors up to 2-1/2" thick
- Name plate

**Aluminum Finishes**

690-1 - Anodized Gold

USPS Approved  
New Construction

Mail Shelters and  
Site Amenities

USPS Approved

Approved  
for Replacement

Private Delivery

Drop / Collection  
Boxes

Chimes

Postal Accessories,  
Locks and Parts



## Organization is Key

Between key rings and mysterious labels, keeping track of keys for numerous resident units can be a nightmare. But a Florence Key Cabinet is just the tool to help property managers get the upper hand and get rid of all those key rings. Each cabinet includes numbered tags that hang in corresponding slots so you can find any key and know which keys are loaned out. The locking cabinets are available in sizes to store anywhere from 30 to 715 keys, giving you access to all your unit keys without lugging around the whole collection. For organization and security, a Florence Key Cabinet is the property manager's best friend.



201-9110-03  
Key Cabinets available in industrial sand finish only

### Standard Features

- Made of welded heavy-gauge steel with piano-hinged door
- Includes standard disc tumbler key lock with two keys
- Vulcanized fiber numbered tags
- Wide angled slots hold keys securely and provide for neat organization
- Industrial sand finish

CATALOG NO.	KEY CAPACITY	DIMENSIONS
201903003	30	12-1/8" H x 8" W x 2-5/8" D
201906003	60	12-1/8" H x 10-5/8" W x 3" D
201911003	110	17-1/8" H x 14" W x 3-1/8" D
201916003	160	20-1/8" H x 16-1/2" W x 4-7/8" D
201924003	240	20-1/8" H x 16-1/2" W x 4-7/8" D
201932003	320	20-1/8" H x 16-1/2" W x 4-7/8" D
201950003	500	31-1/8" H x 16-1/2" W x 7" D
201971503	715	31-1/8" H x 16-1/2" W x 7" D



## Model KK



### Standard Features

- Extruded aluminum construction
- Anodized aluminum finish
- Exterior dimensions:  
6-3/4" H x 6-1/4" W x 2-3/8" D
- Interior dimensions:  
4-5/8" H x 4-1/16" W x 2" D
- Rough opening:  
5-1/8" H x 4-3/8" W x 2-1/4" D

### Optional Features

- Surface mounting collar
- Six powder coat color options

Powder Coat  
Color Options

<b>Sandstone</b> PMS 7501C	<b>Silver Speck</b> PMS 877C
<b>Dark Bronze</b> PMS Black 7C	<b>Gold</b> PMS 871C
<b>Black</b> PMS Black 6C	<b>Postal Grey</b> PMS 413C

MODEL NO.	DESCRIPTION
KK	Loose key type
KKE	Electric switch type
KKR	23" long retractable reel type
KKP	Loose key with private lock
SMKK	Surface mounted collar

## Model K26

The K26 Series key keeper allows postal employees to enter automatically locking entrance doors to distribute mail in accordance with USPS regulations. This model is manufactured to accept postal locks installed by local postal officials.



### Standard Features

- Heavy-gauge brushed stainless steel door
- Formed and painted steel box
- Strong stainless steel piano-type hinge
- Exterior dimensions:  
3-1/4" H x 6" W x 1-15/16" D
- Interior dimensions:  
2-1/8" H x 4-5/8" W x 1-5/8" D
- Rough opening:  
2-1/2" H x 5" W x 1-3/4" D

MODEL NO.	DESCRIPTION
K26	Loose key type prepared for USPS lock
K26R	20" long retractable chain type prepared for master lock
K26P	Push button electrical switch type prepared for master lock
K26C	Loose key type with five-pin cam lock
K26R-C	20" long retractable chain type with five-pin cam lock
K26P-C	Push button electrical switch type with five-pin cam lock

## Replacement Keys



The loss of a mailbox key can be a frustrating experience. For emergency key situations, contact a local locksmith or hardware store. If neither of those are able to assist you, Florence Manufacturing maintains an inventory of key blanks for all Florence mailboxes as well as cut keys for select products. (Make sure to have the manufacturer and number from the key handy for reference sake.)

Orders for replacement keys may be placed through a local locksmith or your local Authorized Florence Dealer. There are instances in which security constraints prevent the cutting of new mailbox keys, in which case we offer replacement locks available through an Authorized Florence Dealer.





## superior customer service



Florence Manufacturing is proud to provide a complete support team to serve all your needs. Not only are customer service representatives ready to assist you with locating an Authorized Dealer or answering your product questions, but a full team of engineering, design, marketing and sales professionals are available as well. This dedicated team can help ensure your project goes as planned each step of the way. Simply call 800-275-1747 or visit [auth-florence.com](http://auth-florence.com) for details.

### stock items / parts

Using contemporary manufacturing processes and equipment in our fully automated 192,000 sq. ft. facility, our efficient, vertically integrated production and quality control standards enable Florence Manufacturing to maintain an inventory of our most popular products. In many instances, these items can ship within 48 hours of ordering. We also offer a variety of replacement parts for each of our product lines. Simply visit our website and click "Parts" to view a complete listing by product.

### returns

All product shipments are adequately packaged, but should be thoroughly inspected upon receipt, and *prior to acceptance*, for potential damage in transit. Returned goods will not be accepted without a returned goods authorization (RGA) number from Florence Manufacturing. Contact your local Authorized Florence Dealer to obtain your RGA number and return address. Stock products may be returned within 90 days of original invoice and are subject to a 30% restocking fee. Custom orders cannot be returned or exchanged.

### care and cleaning

The surface of all Florence products may be cleaned with any mild detergent or properly diluted biodegradable water-based cleaner (such as Simple Green™) and a soft cloth. The use of petroleum-based solvents, ammonia, harsh abrasive cleaners, or scrubbing sponges is not recommended, as in some cases it may damage the product. Cleaning with a damp soft cloth is appropriate. Touch-up paint may be available from an Authorized Florence Dealer for those products which utilize powder coating finish.

### limited warranty

Florence Manufacturing Company provides a five-year warranty, from the date of shipment, covering defects in material and workmanship of all equipment. This warranty guarantees factory replacement and/or repair of all defective items. This warranty does not cover replacement of batteries or any other consumable items, or damage due to improper installation, mishandling, misuse, or acts of nature. We make no other warranties of any kind, either expressed or implied.



*Florence Manufacturing is proud to have set the design standard for all USPS approved CBUs manufactured in the United States.*

### materials

All product descriptions and specifications contained herein were in affect at the time the catalog received final approved for printing. As Florence Manufacturing Company continually strives for efficiencies to pass along to our customers, we reserve the right to change specifications and/or designs without notice and without incurring any liability. Where appropriate, replacement items will be maintained during potential transition.

architectural resources

Get Spec Documents

[Architect Main Page](#) | [Spec Documents](#) | [Find Sales Manager](#)

# Architectural Info.

Spec Drawings and more.

## Product Spec Drawings



Microsoft® Word® Format  
(.doc)



Rich Text Format

**Product Specific Documents:**

- [10552 AF SPEC - 4B+ Horizontal](#)
- [10552 AF SPEC - 4B+ Vertical](#)
- [10552 AF SPEC - 4C Horizontal](#)
- [10500 AF SPEC - vario™ 4C configurable mail shelter kits](#)
- [10552 AF SPEC - CBU / HSCBU](#)
- [10552 AF SPEC - Postal Accessories](#)
- [10552 AF SPEC - Collection Boxes](#)
- [10552 AF SPEC - Parcel Lockers](#)
- [10552 AF SPEC - Private Delivery Horizontal](#)

**Product Specific Documents:**

- [10552 AF SPEC - 4B+ Horizontal](#)
- [10552 AF SPEC - 4B+ Vertical](#)
- [10552 AF SPEC - 4C Horizontal](#)
- [10500 AF SPEC - vario™ 4C configurable kits](#)
- [10552 AF SPEC - CBU / HSCBU](#)
- [10552 AF SPEC - Postal Accessories](#)
- [10552 AF SPEC - Collection Boxes](#)
- [10552 AF SPEC - Parcel Lockers](#)
- [10552 AF SPEC - Private Delivery Horizontal](#)

Download spec documents for all Florence STD-4C, STD-4B+ and Private Delivery products.

**AF FLORENCE**  
manufacturing company

SECTION 10500 - Postal Specialties

Display hidden notes to specifier by using "Tools/Options/View/Hidden Text".

**PART 1 GENERAL**

**1.1 SECTION INCLUDES**

- A. Prefabricated Aluminum & Steel Shelters
- B. Postal Specialties (USPS Approved Wall-Mounted Mailboxes Compliant with USPS STD-4C regulation.)

**1.2 RELATED SECTIONS**

- A. Section 0205 - Site and Steel Shelters
- B. Section 13120 - Prefabricated Metal Buildings and Shelters
- C. Section 06500 - Metal Fabrications

**1.3 REFERENCES**

- A. ASTM A 500 - Standard Specification for Grade B/C Steel Tubing
- B. ASTM A 36 - Standard Specification for Hot Rolled Steel
- C. ASTM B 209 - Standard Specification for Aluminum and Aluminum-Alloy Sheet and Plate
- D. ASTM B 221 - Standard Specification for Aluminum and Aluminum-Alloy Extruded Bars, Rods, Wire, Profiles, and Tubes
- E. ASCE 7 - Minimum Design Loads for Buildings and Other Structures
- F. ICC-IBC 1017.1 - Accessible and Usable Buildings and Facilities

Did you know?

Florence Manufacturing has been included in master specs for decades. Other names we may be listed under include: Auth, Auth-Florence, Auth-Electric, American Device, Cutler, Florence, Florence Manufacturing, and Perma-Bilt.

Stay Current With Changing Guidelines

### U.S. Postal Service STD-4C Specification Highlights

*Effective October 5, 2006, all new designs approved for NEW CONSTRUCTION AND MAJOR RENOVATION require U.S. Postal Service STD-4C compliant mailbox systems. The new USPS 4C Standard includes the following specifications:*

- A new compartment form factor minimum size requirement of 12" w x 6" d x 3" h.
- Eliminates the vertical form factor (5" w x 6" d x 15" h) design.
- Introduces a parcel locker requirement based on a 1:10 parcel locker to customer compartment ratio.
- Strengthens security requirements for the entire receptacle.
- Standardizes and improves tenant compartment lock design.
- Adds testing requirements to verify acceptability for either indoor or outdoor use.
- Introduces quality management systems provisions.
- Enhances design flexibility for concept, ergonomics, and materials.
- Meets Americans with Disabilities Act (ADA) standards.

Auth-Florence versatile™ 4C mailbox suites are designed to meet or exceed the USPS specifications above and in the "Federal Register/Vol. 69, No. 171/September 3, 2004/Rules and Regulations POSTAL 39 CFR Part 111, Standards Governing the Design of Wall-Mounted Centralized Mail Receptacles.

**IMPORTANT NOTE TO ARCHITECTS, SPECIFIERS, DESIGN LAYOUT PROFESSIONALS AND INSTALLERS** - Installation/Layout Instructions Specified in USPS Standard 4C - pages 53821-53831 above referenced USPS 4C Standard "Notes" sections specify:

*All 4C Units shall be designed such that they are in compliance with the following installation requirements:*

1. At least one customer compartment shall be positioned less than 48 inches from the finished floor.
2. No parcel locker compartment (interior bottom shelf) shall be positioned less than 15 inches from the finished floor.
3. No patron (tenant) lock shall be located more than 67 inches above the finished floor.
4. No customer compartment (interior bottom shelf) shall be positioned less than 28 inches from the finished floor.

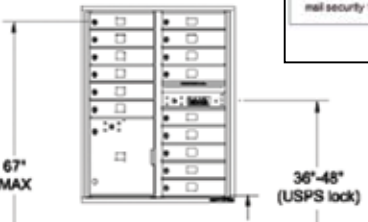

#### Editorials

**Important Links & Downloads**

**USPS STD-4C Compliance Resources**

- [New Specification 10552 for USPS Standard 4C \(rtf\)](#)
- [Federal Register Notice of USPS Standard 4C - September 3, 2004 \(pdf\)](#)
- [AF 4C Horizontal Mailbox Systems Product Brochure \(pdf\)](#)
- [USPS STD-4C Requirements and Installation Specifications \(pdf\)](#)

**Secure Mailboxes**

For Auth-Florence residential mailboxes, commercial mailboxes, apartment mailboxes, CBU mailboxes, secure mailboxes, locking mailboxes, horizontal mailboxes, vertical mailboxes, wall mounted mailboxes, architectural mailboxes and other postal products like mailbox posts, door chimes and key cabinets, Auth-Florence.com is the place.

Auth-Florence is America's leading manufacturer of locking mailboxes, residential mailboxes, commercial mailboxes, wall mounted mailboxes, mail drop boxes and apartment mailboxes built to reduce identity theft and mail theft while improving mail security and mail safety. Auth-Florence mailboxes and other postal products make safe mail, mail security and identity theft prevention priority #1. Apartment mailboxes can be wall-mounted horizontal mailboxes, vertical mailboxes or freestanding CBUs that are mounted to a mailbox post. Auth-Florence also offers door chimes, drop boxes, key cabinets, mailbox posts and other safe mail products that prevent identity theft and improve mail security.

Many residential mailboxes are not locking mailboxes. These non-secure mailboxes threaten safe mail, putting them at risk for mail theft and identity theft. Safe mail products from Auth-Florence such as residential mailboxes, commercial mailboxes, apartment mailboxes, CBU mailboxes, locking mailboxes, horizontal mailboxes, vertical mailboxes, wall mounted mailboxes and other postal products like mailbox posts, door chimes, drop boxes and key cabinets improve mail security for both commercial mailbox and residential mailbox applications.

Review important specification and guideline documents for mandatory STD-4C compliance or accessibility issues.

catalog index

4C, versatile™ mailbox collars - USPS Approved, NEW .....	11	MUCK - Multi-Unit Connector Kit, 4C versatile™ mailbox suites .....	11
4C, versatile™ mailbox suites - USPS Approved		New Products .....	5
Front Load .....	10-13, 14-17, 19	4C Collar .....	11
Rear Load, NEW .....	11	4C Rear-Load .....	11
About Us .....	2, 21, 29, 30, 49	Chimes Sliding Viewer Cover .....	44
Accessibility .....	15	Hudson Combination Lock .....	31
American Device, 2600 Series Horizontal Mailbox - USPS Approved .....	28-31	vicinity™, mail station accessories .....	21
Architectural Specifications .....	49	sentinel™ solar site lite .....	9, 21
Authorized Florence Dealer Locator .....	3, 51	Florence Site Furnishings .....	21
Awards, USPS .....	2, 6, 22	valiant™, 1590 OPL Series - USPS Approved .....	22
Benches, Florence Site Furnishings, NEW .....	21	vario™, pre-engineered mail shelter kits .....	16-20
Bike Racks, Florence Site Furnishings, NEW .....	21	vogue™, 1570 CBU accessories .....	7
Book Depository .....	43	Online Resources .....	51
Care and Cleaning .....	48	Outdoor Parcel Locker, valiant™ - USPS Approved, NEW .....	22
Chimes .....	44-45	Planters, Florence Site Furnishings, NEW .....	21
Cluster Box Units		Postal Accessories	
vital™ 1570 CBU series - USPS Approved .....	6-7	Key Cabinet .....	46
vigilant™ 1565 High Security CBU series - USPS Approved .....	8-9	Key Keepers .....	47
vogue™ 1570 CBU Accessories, NEW .....	7	Postal Regulations, USPS .....	14, 24, 25, 26, 32
Collars		Private Delivery	
4C, versatile™ mailbox, NEW .....	11	1450/1550 Horizontal Series .....	36-37
1250 Vertical Series - USPS Approved .....	32-33	1600/1700 Horizontal Series .....	38-39
Collection Boxes (see also drop boxes)		Quotations, Authorized Florence Dealer .....	51
1250 Vertical Series - USPS Approved .....	33	Rear-Load	
1400/1500 Horizontal Series - USPS Approved .....	25	4C Rear-Load, NEW .....	11
2600 American Device Integral Unit - USPS Approved .....	29	1450/1550 Series - Private Delivery .....	36
CC Series .....	42-43	1500 Horizontal Series - USPS Approved .....	24
Colors .....	6, 8, 10, 16, 20, 22, 23, 24, 28, 32, 35, 36, 38, 40, 42, 44, 47	1600/1700 Vertical Series - Private Delivery .....	38
Configurator .....	3, 19, 51	2600 American Device Horizontal Series - USPS Approved .....	28
Copyright .....	51	CCF60SM Collection Box .....	42
Customer Service .....	48	Receptacles, (Litter and Ash) Florence Site Furnishings, NEW .....	21
Dealers, Authorized Florence .....	3, 51	Recycling .....	2
Directories		Replacement Keys .....	47
1250 Vertical Series - USPS Approved .....	33	Replacement Mailboxes	
1400/1500 Horizontal Series - USPS Approved .....	25	1250 Vertical Series - USPS Approved .....	32-34
2600 American Device Series - USPS Approved .....	29	1400/1500 Horizontal Series - USPS Approved .....	24-26
Door Options .....	25, 29, 37, 39	2600 American Device Horizontal Series - USPS Approved .....	28-31
Drop Boxes (see also collection boxes)		Replacement Parts .....	48
12/120 Series .....	40	Returns .....	48
130 Series - USPS Approved .....	40	Security Upgrade	
140/150 Series .....	40	1250 Vertical Series - USPS Approved .....	34
LD12 Series Letter .....	41	1400/1500 Horizontal Series - USPS Approved .....	26
Engraving .....	27	Shelter, vario™ .....	16-20
Florence Manufacturing Company .....	2, 21, 29, 30	Single Family Residential Mailbox, MB 2000 - USPS Approved .....	23
Florence Site Furnishings, NEW .....	21	Solar Lights	
Gibraltar Industries .....	30	sentinel™ solar site lite, NEW .....	9, 21
High Security Cluster Box Unit, vigilant™ 1565 series - USPS Approved .....	8-9	vario™, NEW .....	20
Horizontal Mailbox		STD-4B+ Postal Regulations .....	24, 26
1400/1500 Series - USPS Approved .....	24-26	STD-4C Postal Regulations .....	14, 25, 32
2600 American Device Series - USPS Approved .....	28-31	Stock Items .....	23, 48
1450/1550 Series / 1600/1700 Series - Private Delivery .....	36-39	USPS Approved	
ID Options .....	7, 9, 11, 22, 27	1250 Vertical Series .....	32-34
Installation, Authorized Florence Dealer .....	51	130 Drop Box Series .....	40
Installation Instructions		1400/1500 Horizontal Series .....	24-26
1250 Vertical Series - USPS Approved .....	34	2600 American Device Horizontal Series .....	28-31
1400/1500 Horizontal Series - USPS Approved .....	26	MB 2000 Single Family Residential Mailbox .....	23
1450/1550 Horizontal Series - Private Delivery .....	37	valiant™ 1590 OPL Series .....	22
1600/1700 Vertical Series - Private Delivery .....	39	versatile™ 4C mailbox suites (front and rear load) .....	10-13, 15
4C Mailbox Suites - USPS Approved .....	15	vigilant™ 1565 High Security CBU series .....	8-9
Chimes .....	44	vital™ 1570 CBU series .....	6-7
MB 2000 Single Family Residential - USPS Approved .....	23	USPS Awards .....	2
ISO Certified .....	2	USPS Contract .....	2, 6, 22, 30
Key Cabinets .....	46	USPS Partnership .....	2, 14, 22, 36, 48
Key Keepers .....	47	USPS Regulations .....	14, 24, 25, 26, 32
Keys, Replacement .....	47	valiant™, 1590 OPL Series - USPS Approved, NEW .....	22
Letter Drop, LD12 Series .....	41	vario™, pre-engineered mail shelter, NEW .....	16-20
Lights		versatile™, 4C mailbox suites - USPS Approved .....	10-13, 15
LED, vario™ (solar and AC), NEW .....	20	Vertical Mailbox	
Solar, sentinel™ site lite, NEW .....	9, 21	1250 Series - USPS Approved .....	32-34
Limited Warranty .....	48	vicinity™, Mail Station Accessories, NEW .....	21
Locator, Authorized Florence Dealer .....	3, 49	vigilant™, 1565 High Security CBU series - USPS Approved .....	8-9
Locks .....	5, 7, 9, 11, 22, 23, 25, 29, 31, 33, 37, 39	vital™, 1570 CBU series - USPS Approved .....	6-7
Lock Options, Horizontal .....	31	vogue™, 1570 CBU accessories, NEW .....	7
Lock Suppliers .....	31	Warranty, Limited .....	48
Mail Station Accessories, vicinity™, NEW .....	21	Weights	
Mail Shelter, vario™ (pre-engineered), NEW .....	16-20	4C Weight Chart .....	13
Materials .....	48	vigilant™ 1565 HSCBU series - USPS Approved .....	8-9
MB 2000, Single Family Residential - USPS Approved .....	23	vital™ 1570 CBU series - USPS Approved .....	6-7



# superior online resources



Downloadable Tools



Find a Dealer



Design a Mailbox



Get a Quote

Florence Manufacturing has developed extensive online resources to assist with all your projects. Whether you are an architect looking for a three-part specification, a builder needing product dimensions and rough opening calculations, or a property manager looking for the latest in postal regulations, it is all at [auth-florence.com](http://auth-florence.com). Plus, our nationwide dealer locator not only assists you in finding your local dealer, but will show you installations they have done within the area. Using our one-of-a-kind mailbox configurator gives you superior resources right at your finger tips.

## quotations and installation

A local Authorized Florence Dealer is standing by to provide an individual product or complete project quote - as well as product specification, installation and/or any necessary technical documents you may require. To quickly submit a quote request, visit [auth-florence.com](http://auth-florence.com), add your desired selections to your shopping cart and click QUOTE THIS ITEM. Our Authorized Dealers are also ready to assist with your specific product installation needs. Most products are shipped pre-assembled and ready for final installation; however, further assistance is available from many local Authorized Dealers. It is always a good idea to consult with local postal authorities for local approval and current installation requirements to complete all USPS approved product installations.



## copyright

Florence Manufacturing has made every effort possible to ensure the accuracy of all information contained within this publication. We reserve the right to correct inadvertent or typographical errors, inaccuracies or omissions - should they happen to occur - and to change or update information at any time without prior notice. All publication elements, including but not limited to, design, graphics, text, trademarks, art, and photographs, as well as the selection and arrangement thereof, are Copyright © 2008 Florence Corporation, all rights reserved. This catalog is intended for distribution by Florence Manufacturing and its Authorized Dealers for the sole purpose of purchasing products contained herein. Any other use of this publication, including modification or re-publication of any portion of the publication, without the prior written consent of Florence Manufacturing, is strictly prohibited.

COPYRIGHT © 2008 FLORENCE CORPORATION. ALL RIGHTS RESERVED. CATALOG SUBJECT TO CHANGE WITHOUT NOTICE. PRINTED IN THE USA.



800.275.1747  
auth-florence.com

**AF FLORENCE**  
manufacturing company  
A GIBRALTAR INDUSTRIES COMPANY 