



TABLE OF CONTENTS

A.D.A. Signs _____	50	Dutch Door Bolts _____	25	Push/Pull Plate & Cylinder Pull _____	12
Alum. Frame Filler Plates _____	45	Edge Pulls _____	62	Range Shields _____	6
Angle Plates _____	6	Elbow Catch _____	61	Reinforcement Plates _____	49
Angle Stop _____	20	Fasteners _____	25	Remodeler Plates _____	59
ANSI Strikes _____	53	Fastening Methods for Door Pulls _____	13	Replacement Knobs _____	61
Applied Stop _____	21	Filler Plates _____	45	Replacement Strikes _____	53
Automatic Flush Bolts _____	23	Filler Plates _____	46	Rigid Base Stops _____	20
Ball Latches _____	24	Filler Plate Kits _____	45	Roller Bumpers _____	18
Cabinet Knob _____	13	Finger Pull _____	61	Roller Latches _____	23
Cabinet Pulls _____	12	Finish Descriptions _____	57	Round & Flat Door Pulls _____	10
Cast Door Pulls _____	9	Flat Front Wrap-Arounds _____	37	Scar Plates _____	59
Cast Wall Bumpers _____	15	Floor Stops _____	16	Scar Plates _____	62
Chain Guard _____	60	Flush Bolts _____	23	Security Strikes _____	55
Coat Hooks _____	61	Flush Cup Pulls _____	12	Security Strikes _____	57
Commercial Kick Plates _____	5	Hand Rail Brackets _____	60	Series 8 Strikes _____	56
Concealed Stop _____	28	Heavy Duty Crash Chain _____	28	Series 12 Strikes _____	56
Coordinators _____	27	Hinge Pins _____	61	Series 18 Strikes _____	56
Corner Guards _____	6	Hinge Reinforcements _____	47	Slide Bolts _____	24
Crash Chain _____	62	Hinge Stop _____	20	Slide Bolts _____	25
Cylinder Pull _____	12	Hole Filler Plates _____	46	Spreader Bars _____	48
Decals _____	50	Hospital Latch _____	29	Spring Base Stops _____	20
Detention Stop _____	18	Hospital Pulls _____	9	Strap Anchors _____	48
Display Packaged Kick Plates _____	7	Interior Wrap-Arounds _____	37	Strike Reinforcements _____	48
Display Packaged Push/Pull Plates _____	13	Latch Protectors _____	39-43	Surface Holder _____	28
Door Flip Guards _____	60	Lip Strikes (Extended) _____	54	Surface Stop _____	28
Door Holders _____	19	Lip Strikes (Extended) _____	55	Tabs _____	48
Door Holders _____	20	Magnetic Catches _____	24	T-Strikes (Extended) _____	54
Door Knockers _____	62	Numbers _____	62	Thimble Strike _____	55
Door Silencers _____	21	Offset Door Pulls _____	11	Title 24 Signs _____	49
Door Stops _____	17	Pocket Door Locks _____	59	U-Channels _____	6
Door Stops _____	18	Pull Plates _____	10	Vertical Rod Protector _____	6
Door Stops _____	21	Push Plates _____	9	Wall Bumpers _____	15
Door Viewers _____	60	Push/Pull Bars _____	11	Window Bolts _____	61
Double Lip Strikes _____	55	Push/Pull Plate _____	12	Wrap-Arounds _____	31-37
Dust Proof Strikes _____	23	Push/Pull Plate w/Holes _____	9	Wrought Wall Bumpers _____	15

ITEM LISTING

ITEM #	PG. #	ITEM #	PG. #	ITEM #	PG. #	ITEM #	PG. #	ITEM #	PG. #	ITEM #	PG. #
1-CW _____	31	5K-CW _____	34	12-CW _____	32	17 _____	10	20C-CW _____	33	33-CW _____	36
2-CW _____	31	6-CW _____	31	12-2-CW _____	32	17-CW _____	35	20-FE _____	37	33A-2-CW _____	36
2-SDS _____	55	7-CW _____	31	14 _____	10	18-CW _____	35	21 _____	10	33A-CW _____	36
2-SS _____	55	8-CW _____	31	14-CW _____	36	19 _____	10	22 _____	10	35 _____	9
2-SDS-8 _____	55	9-CW _____	34	14-2-CW _____	36	19-CW _____	35	27-CW _____	35	36 _____	9
3-CW _____	31	9K-CW _____	34	15 _____	10	20 _____	10	30 _____	10	37 _____	10
4-CW _____	31	10 _____	9	15-CW _____	34	20-CW _____	33	30-CW _____	33	38 _____	10
4-2-CW _____	34	10-FE _____	37	16 _____	10	20-2-CW _____	33	31 _____	10	39 _____	10
5-CW _____	31	11 _____	10	16-CW _____	35	20B-CW _____	33	32 _____	10	40-CW _____	33



ITEM LISTING

ITEM #	PG. #	ITEM #	PG. #	ITEM #	PG. #	ITEM #	PG. #	ITEM #	PG. #	ITEM #	PG. #
42	9	484-CW	32	1487	18	1858	12	A-2-SS	57	CHS-5	49
44	9	486-CW	33	1488	18	1860	12	AF-29	45	CLP-106	41
51-CW	31	504-CW	36	1490	17	1866	12	AF-29L	45	CLP-110	41
54	13	504-FE	37	1492	17	1874	12	AF-260	45	CP-258	46
56	13	514-CW	36	1500	20	2011	27	AF-261	45	CR-060	49
55-CW	36	942-CW	33	1501	20	2012	27	AF-291	45	CR-125	49
55A-CW	36	943-CW	33	1502	20	2021	27	AF-291L	45	CR-275	49
55A-2-CW	36	946-CW	33	1503	20	2022	27	AL-211	43	CR-300	49
58	13	1150	11	1504	20	2023	27	ALP-206	42	CV-86	46
59	13	1151	11	1506	20	2033	27	ALP-210	42	CV-2414	46
61-CW	31	1152	11	1508	20	2040	27	AP-34	60	CV-8624	46
62	12	1156	11	1509	20	2050	27	AR-335	46	DBS-386	45
64	12	1157	11	1510	20	2051	27	AR-9K	46	DBS-1478	53
66	12	1158	11	1514	20	2060	27	AST-21341	56	DBS-2478	53
70	9	1159	11	1520	19	2080	27	AST-21342	56	DCB-270	47
70-CW	33	1288	6	1521	19	3023	28	AST-21346	56	DCB-280	47
71	9	1289	6	1522	19	3024	28	AST-2134M	56	DCB-340	48
71-CW	31	1290	6	1523	19	3123	28	AST-21381	56	DCB-350	48
72	9	1295	6	1555	23	3124	28	AST-2138M	56	DD-1	50
73	9	1298	6	1557	23	3212	28	AST-21382	56	DD-2	50
75-CW	34	1299	6	1560	23	3323	28	AST-21386	56	DD-3	50
80-CW	33	1400	15	1562	23	3324	28	BF-135	46	DD-4	50
81	6	1401	15	1570	23	4000-2-CW	34	BF-161	46	DL-11	55
81-CW	31	1402	15	1572	23	4000-4-CW	34	BF-178	46	DL-12	55
81-2-CW	34	1406	15	1578	24	4500	29	BFD-2	53	DS-234	53
83	6	1407	15	1580	24	4550	29	BK-225	61	DSP-135	59
85	6	1410	15	1582	24	7010	10	BLP-107	41	DST-161	53
90	5	1412	15	1590	61	7011	10	BLP-110	41	DV-90	60
90-CW	33	1413	15	1603	60	7014	10	BLP-207	41	DV-180	60
91	5	1420	21	1604	60	7015	10	BLP-210	41	EF-86	46
92	5	1430	21	1607	60	7016	10	BN4	62	EF-160	46
93	5	1432	21	1608	21	7030	10	BS-161	53	EF-161	46
93-KV-CW	35	1440	16	1609	21	7031	10	BTS-160	45	EF-161-S	46
95-CW	34	1442	16	1610	21	7110	10	CC-100	62	EF-161-TG	46
104	62	1443	16	1611	62	7111	10	CFC70	9	EF-634	46
106	62	1444	16	1613	62	7114	10	CFC71	9	EL-86	46
125	61	1445	16	1630	25	7115	10	CFC7015	9	EL-102	54
130	60	1446	16	1632	25	7116	10	CFC7115	9	EL-103	54
135	60	1448	17	1634	25	7130	10	CFD70	9	EL-104	54
147	11	1449	17	1636	25	7131	10	CFD71	9	EL-115	54
151-CW	32	1450	18	1638	25	7210	10	CFD7015	9	EL-125	54
154-CW	32	1452	18	1639	25	7310	10	CFD7115	9	EL-175	54
200-CW	36	1453	18	1640	23	7816	12	CFL70	9	EL-202	54
200C-CW	36	1455	19	1640R	23	9102	54	CFL71	9	EL-203	54
212-CW	36	1462	18	1700	23	9211	40	CFL7015	9	EL-204	54
212C-CW	36	1465	19	1702	23	9234	53	CFL7115	9	EL-205	54
214-CW	36	1466	19	1704	23	19147	11	CFK70	9	EL-225	54
214C-CW	36	1467	19	1712	24	20147	11	CFK71	9	ELP-208	42
256-CW	32	1468	19	1714	24	21147	11	CFK7015	9	ELP-208P	42
258-CW	32	1471	17	1716	24	22147	11	CFK7115	9	EM-2	62
261-CW	32	1473	17	1720	24	1156147	11	CHP-100	61	EM-4	62
264-CW	32	1475	17	1722	24	1157147	11	CHS-1	49	EST-102	54
300	61	1477	17	1724	24	1158147	11	CHS-2	49	EST-103	54
302	61	1480	20	1848	12	1159147	11	CHS-3	49	EST-104	54
481-CW	32	1486	18	1850	12	A-2-SDS	57	CHS-4	49	EST-115	54



ITEM LISTING

ITEM #	PG. #	ITEM #	PG. #	ITEM #	PG. #	ITEM #	PG. #	ITEM #	PG. #	ITEM #	PG. #
EST-125	54	FS-260	45	HS-9060-05	50	KLP-110-LHR	42	NLP-106	41	SB-6	25
EST-158	54	GLP-307	39	HS-9060-07	50	KLP-110-RHR	42	NLP-110	41	SB-12	25
EST-175	54	HDCC-2012	28	HS-9060-08	50	KP-628	7	NLP-206	41	SHF-45	46
ETS-102	54	HDCC-2512	28	HS-9060-22	50	KP-630	7	NLP-210	41	SLP-106	43
ETS-103	54	HDCC-3012	28	HS-9060-24	50	KP-632	7	OLP-2650	39	SLP-206	43
ETS-104	54	HD-1	50	HS-9060-27	50	KP-634	7	OLP-2651	39	SP-135	59
ETS-115	54	HF-45	46	HS-9060-32	50	KP-828	7	PDF-161	46	SPB-30	48
ETS-125	54	HR-100	47	HS-9060-35	50	KP-830	7	PDL-100	59	SPB-60	48
ETS-175	54	HR-110	47	HS-9060-36	50	KP-832	7	PDL-101	59	SPB-80	48
FB-225	45	HR-120	47	HS-9060-37	50	KP-834	7	PL-13515	13	ST-134	53
FBRK-2	45	HR-130	47	HS-9070-01	50	LP-107	41	PLP-111	40	ST-144	53
FF-45	45	HR-140	47	HS-9070-02	50	LP-111	40	PLP-211	40	ST-161	53
FF-50	45	HR-150	47	HS-9070-03	50	LP-207	41	PMLP-111	40	ST-261	53
FL-208N	56	HR-160	47	HS-9070-04	50	LP-211	40	PMLP-211	40	ST-214	53
FL-208W	56	HR-170	47	HS-9070-05	50	LP-307	39	PS-13515	13	ST-214-RC	53
FL-208NM	56	HR-180	47	HS-9070-06	50	LP-312	43	RHP-100	61	ST-261	53
FL208WM	56	HR-190	47	HS-9070-07	50	LP-312P	43	RP-13509	59	ST-386	45
FL-212N	56	HR-200-4 1/2	47	HS-9070-08	50	LP-2878	43	RP-13509-2	59	TB-215	48
FL-212N4	56	HR-210-5	47	HS-9070-22	50	LW-86	46	RP-13515	59	TS-100	55
FL-212N6	56	HR-215-4 1/2	47	HS-9070-24	50	MEST-102	55	RP-13515-2	59	TS-234	53
FL-212NM	56	HR-216-5	47	HS-9070-27	50	MEST-103	55	RP-13545	59	ULDV-90	60
FL-212W	56	HR-217	47	HS-9070-32	50	MEST-104	55	RP-13545-2	59	ULDV-180	60
FL-212W4	56	HR-218	47	HS-9070-35	50	MEST-115	55	RPK-109	59	VBF-161	46
FL-212W6	56	HS-060	45	HS-9070-46	49	MEST-125	55	RS2430	6	WB-112	61
FL-212WM	56	HS-090	45	HS-9070-47	49	MEST-175	55	SA-615	48	WP-34	60
FLP-111	42	HS-9060-01	50	HS-9070-48	49	MLP-111	40	SA-618	48		
FLP-211	42	HS-9060-02	50	HS-9080-02	50	MLP-211	40	SB-2	25		
FPK-86	45	HS-9060-03	50	ILP-206	39	MST-161	53	SB-3	25		
FPK-161	45	HS-9060-04	50	ILP-212	39	MST-261	53	SB-4	25		



COMMERCIAL KICK PLATES

ARMOR PLATE

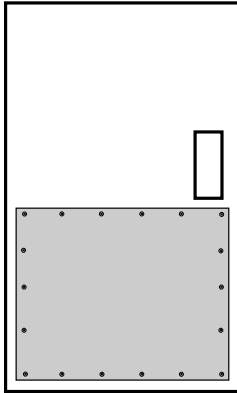

Used on doors subject to marring or damage from carts, trucks, etc.

ANSI:
J101 Metal J105 Plastic

KICK PLATE

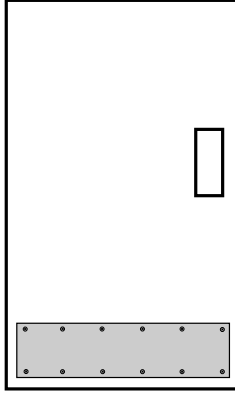

Used on doors subject to marring or damage from foot traffic.

ANSI:
J102 Metal J106 Plastic

MOP PLATE

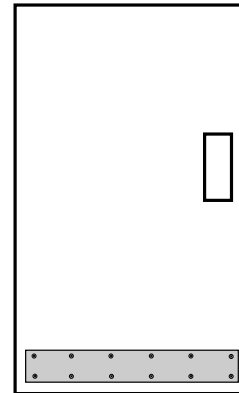

Used on doors subject to marring or damage during cleaning operations.

ANSI:
J103 Metal J107 Plastic

- Individually packaged with screws
- Full threaded to the head stainless steel sheet metal screws with plated finish
- Beveled 3 or 4 sides optional
- Commercial grade thickness
- Other thicknesses available on special order
- Furnished with grain or satin finish running horizontally to door
- Finishes: 605, 606, 609, 612, 613, 619, 620, 626, 628, 629, 630, Brass Tone (BT), Dark Anodized Aluminum (DB), Kydex, and **Endurance**.™
- Plastic colors include: Black, Brown, Gray, Beige, White, Clear

NUMBER	MATERIAL
90	.050 Metal
91	.038 Metal
92	.125 Plastic
93	.125 Clear Plastic

How to Order: Height x Length x Finish
e.g.: 8" X 34" - 630

Warnock Hersey



New WARNOCK HERSEY LISTED ARMOR PLATES

We now offer Armor Plates for fire rated 3 hour metal doors. Please specify prefix "WH" when ordering (i.e. WH-48" x 48"-630). Screw mount only. There is a \$5.00 per plate additional charge.

RANGE SHIELDS



RS2430

NUMBER	DIMENSIONS
RS2430	24" x 30"

SHELF PACK: 4
FINISHES: White, Almond
 22 (.032) Gauge

VERTICAL ROD PROTECTOR

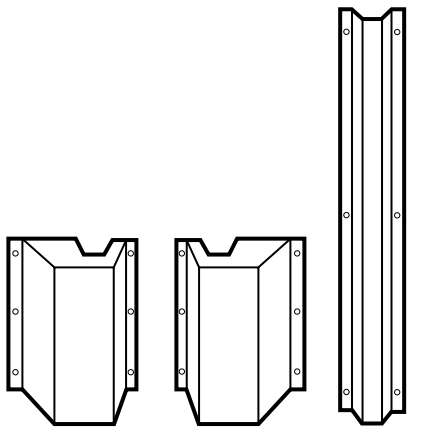

#81 For use on right hand reverse doors
#83 For use on left hand reverse doors
#85 Rod Cover

NUMBER	DESCRIPTION	DIMENSIONS
81	Latch bolt cover	2 1/8" projection
83	Latch bolt cover	2 1/8" projection
85	Rod cover	24" x 1 1/16"

SHELF PACK: 1
FINISHES: 630
 18 (.050) Gauge

- Assist in handicap conformance
- Use in hospitals, schools, etc.
- Installs with #6 x 3/4" screws directly into the door.
- Installs on any type of wood, metal or plastic door, any thickness. Covers the latching bolt and lower portion of the vertical rod assembly.
- Fire rated
- Stainless Steel, Satin Finish

CORNER GUARDS / U-CHANNELS / ANGLE PLATES

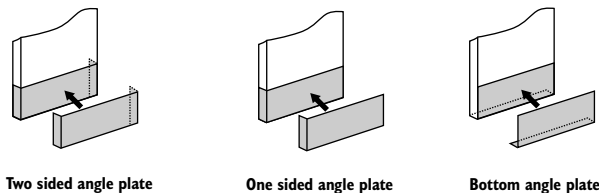

Two sided angle plate One sided angle plate Bottom angle plate

I288/I289

NUMBER	MOUNTING
I288	Scotch Mount
I289	Sheet Metal Screw
I290	Scotch Mount
I295	Sheet Metal Screw
I298	Scotch Mount
I299	Sheet Metal Screw

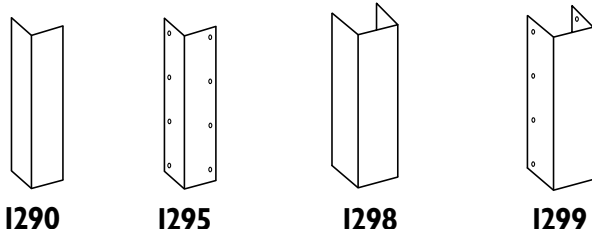

I290 **I295** **I298** **I299**

How to Order: Leg x Door Width x Leg x Height

SHELF PACK: 1
FINISHES: 605, 606, 609, 612, 613, 628, 629, 630

- Specify size (standard size 3" x 3" x 40")



DISPLAY PACKAGED KICK PLATES for decorating or repairing doors

Innovative packaging includes an outer corrugation that insures the inner package will remain fresh for display. Package allows for hanging or stacking.

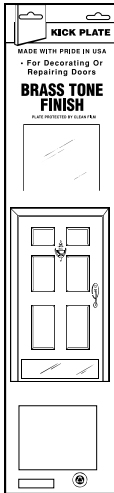

NUMBER	DIMENSIONS
KP-628	6" x 28"
KP-630	6" x 30"
KP-632	6" x 32"
KP-634	6" x 34"
KP-828	8" x 28"
KP-830	8" x 30"
KP-832	8" x 32"
KP-834	8" x 34"

SHELF PACK: 1 Display Packaged Size - 8 1/4" x 38 1/2"
FINISHES: (KP-628, KP-630, KP-632, KP-634) **605, 630**
 (KP-828, KP-830, KP-832, KP-834) **605, 628, 630, Brass Tone (BT)**



ENDURANCE™

Finish by Don-Jo® BRASS FINISH...lasts forever.

Don-Jo Mfg. Inc. is pleased to announce that we now have kick plates available with the **ENDURANCE™ FINISH.**

Featuring the PVD finish process, these plates are guaranteed, in writing, against

- TARNISHING • FLAKING • PITTING • DISCOLORATION

They are packaged in our traditional brown kraft paper and are available in any size up to 48" x 48".



PUSH PLATES

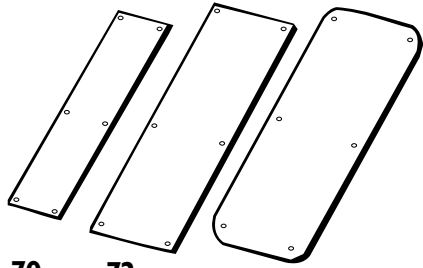

70 72
71 73 72RC

NUMBER	ANSI	DIMENSIONS
70	J301	3 1/2" x 15"
71	J301	4" x 16"
72	J301	6" x 16"
73	J301	8" x 16"

SHELF PACK: 10

FINISHES: 605, 606, 609, 612, 613, 619, 620, 626, 628, 629, 630

- Beveled edges, adhesive mounting, rounded corners, cylinder cut-outs are available
- Other finishes include clear plastic and Kydex stock colors

PUSH PLATES & PULL PLATES WITH HOLES

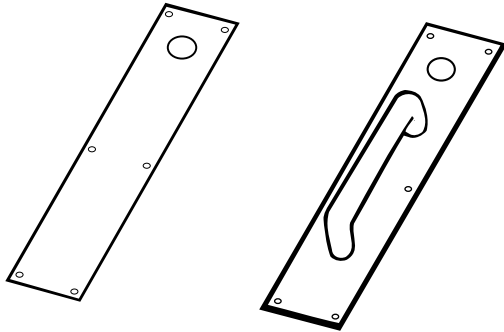

NUMBER	PULL	DIMENSIONS
*70	-	3 1/2" x 15"
*71	-	4" x 16"
*7015	15	3 1/2" x 15"
*7115	15	4" x 16"

SHELF PACK: (70, 71) 10

Box Packaged

(7015, 7115) 1

FINISHES: 605, 606, 612, 613, 628, 629, 630

***HOLE SIZE: CFC 1 1/4" - CFD 1 1/2" - CFK 2 1/8" - CFL 2 1/8" with lever prep**

How to Order: Hole Size, Number, Finish
e.g.: CFC70 - 605

CAST DOOR PULLS



10 35 36

NUMBER	CTC	DIMENSIONS	ANSI
10	5 1/2"	6 5/8" x 1 3/4" x 1 5/16"	J401
35	5 1/2"	7 1/2" x 2" x 1 1/2"	J401
36	5 1/2"	7 1/2" x 2" x 1 1/2"	J401

SHELF PACK: 1

• Dimensions - Overall x Projection x Clearance

FINISHES: (10) 605, 612, 613, 628, 630

(35, 36) 605, 613, 625, 626

HOSPITAL PULLS

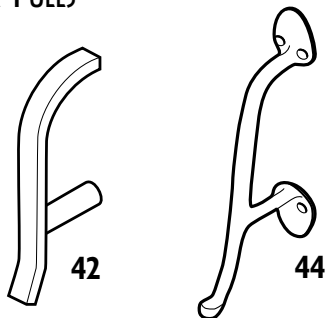

42 44

NUMBER	CTC	DIMENSIONS	ANSI
42	5"	6 1/2"	J401
44	6"	9 1/4"	J401

SHELF PACK: 1

FINISHES: (42) 605, 613, 626, 630

(44) 605, 613, 630

ROUND & FLAT DOOR PULLS

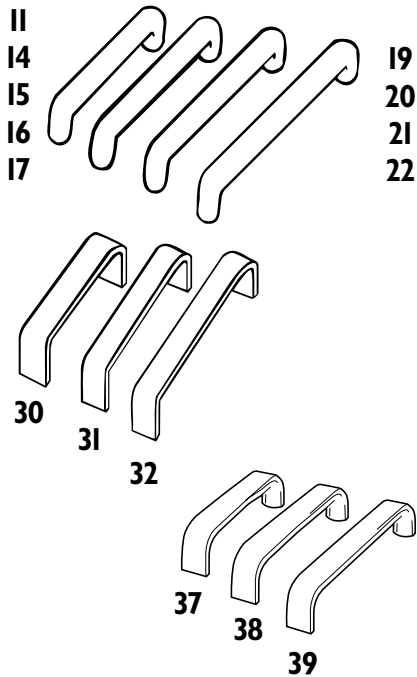

NUMBER	CTC	DIAMETER	ANSI	DIMENSIONS
11	5 1/2"	5/8"	J401	6 1/8" x 2" x 1 3/8"
14	5 1/2"	3/4"	J401	6 1/4" x 2 1/4" x 1 1/2"
15	6"	3/4"	J401	6 3/4" x 2 1/4" x 1 1/2"
16	8"	3/4"	J401	8 3/4" x 2 1/4" x 1 1/2"
17	10"	3/4"	J401	10 3/4" x 2 1/4" x 1 1/2"
19	8"	1"	J401	9" x 3" x 2"
20	10"	1"	J401	11" x 3" x 2"
21	12"	1"	J401	13" x 3" x 2"
22	18"	1"	J401	19" x 3" x 2"
30	6"	3/8" x 1 1/4"	J401	6 3/8" x 2" x 1 5/8"
31	8"	3/8" x 1 1/4"	J401	8 3/4" x 2" x 1 5/8"
32	10"	3/8" x 1 1/4"	J401	10 3/8" x 2" x 1 5/8"
37	6"	1" Half Round	J401	6 1/2" x 2" x 1 1/2"
38	8"	1" Half Round	J401	8 1/2" x 2" x 1 1/2"
39	10"	1" Half Round	J401	10 1/2" x 2" x 1 1/2"

SHELF PACK: I • Dimensions - Overall x Projection x Clearance

FINISHES: (11, 14, 15, 16, 17, 19, 20, 21, 22) 605, 606, 612, 613, 628, 629, 630

(30, 31, 32, 37, 38, 39) 605, 613, 628, 630

- For 2 1/2" clearance add prefix "H" - N/A on models 30 - 39
- Made from solid bar stock

PULL PLATES

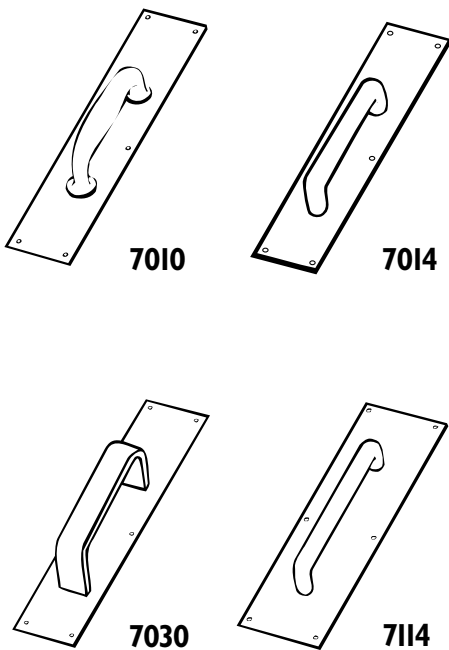

NUMBER	CTC	PULL	ANSI	DIMENSIONS
7010*	5 1/2"	6 5/8" x 1 3/4" x 1 15/16"	J405	3 1/2" x 15"
7011	5 1/2"	5/8"	J405	3 1/2" x 15"
7014	5 1/2"	3/4"	J405	3 1/2" x 15"
7015	6"	3/4"	J405	3 1/2" x 15"
7016	8"	3/4"	J405	3 1/2" x 15"
7030	6"	3/8" x 1 1/4"	J405	3 1/2" x 15"
7031	8"	3/8" x 1 1/4"	J405	3 1/2" x 15"
7110*	5 1/2"	6 5/8" x 1 3/4" x 1 15/16"	J405	4" x 16"
7111	5 1/2"	5/8"	J405	4" x 16"
7114	5 1/2"	3/4"	J405	4" x 16"
7115	6"	3/4"	J405	4" x 16"
7116	8"	3/4"	J405	4" x 16"
7130	6"	3/8" x 1 1/4"	J405	4" x 16"
7131	8"	3/8" x 1 1/4"	J405	4" x 16"
7210*	5 1/2"	6 5/8" x 1 3/4" x 1 15/16"	J405	6" x 16"
7310*	5 1/2"	6 5/8" x 1 3/4" x 1 15/16"	J405	8" x 16"

SHELF PACK: I

FINISHES: 605, 606, 612, 613, 628, 629, 630, *not available in 606

- For 2 1/2" clearance add prefix "H" (not available on all models)
- First two digits indicate plate size, second two digits indicate pull style
- Other sizes and combinations available. Contact factory



OFFSET DOOR PULLS

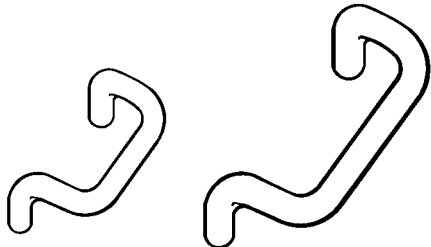

1150 / 1151
1152

1156 / 1157
1158 / 1159

NUMBER	CTC	DIAMETER	ANSI	DIMENSIONS
1150	8"	3/4"	J402	8 3/4" x 2 3/4" x 2"
1151	10"	3/4"	J402	10 3/4" x 2 3/4" x 2"
1152	12"	3/4"	J402	12 3/4" x 2 3/4" x 2"
1156	8"	1"	J402	9" x 3" x 2"
1157	10"	1"	J402	11" x 3" x 2"
1158	12"	1"	J402	13" x 3" x 2"
1159	18"	1"	J402	19" x 3" x 2"

SHELF PACK: 1
FINISHES: 605, 606, 613, 628, 629, 630
• Made from solid bar stock

• Dimensions - Overall x Projection x Clearance

PUSH/PULL BARS

PULL				PUSH			
NUMBER	CTC	PROJECTION	CLEARANCE	CTC	PROJECTION	CLEARANCE	ANSI
147	Specify	2 1/2"	1 1/2"	-	Specify	1 1/2"	J501
19147	8"	3"	2"	Specify	2 1/2"	1 1/2"	J504
20147	10"	3"	2"	Specify	2 1/2"	1 1/2"	J504
21147	12"	3"	2"	Specify	2 1/2"	1 1/2"	J504
22147	18"	3"	2"	Specify	2 1/2"	1 1/2"	J504
1156147	8"	3"	2"	Specify	2 1/2"	1 1/2"	J504
1157147	10"	3"	2"	Specify	2 1/2"	1 1/2"	J504
1158147	12"	3"	2"	Specify	2 1/2"	1 1/2"	J504
1159147	18"	3"	2"	Specify	2 1/2"	1 1/2"	J504

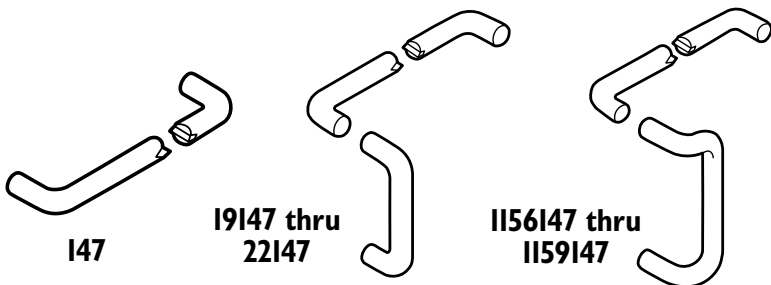

147

19147 thru
22147

1156147 thru
1159147

SHELF PACK: 1
FINISHES: 605, 606, 613, 628, 629, 630
• Made from solid bar stock

How to Order: Number, Size, Finish
eg: 22147 - 32" - 630

See page 13 for mounting options

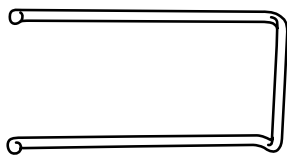

19148 thru 22148

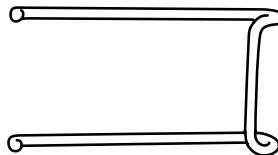

1156148 thru 1159148

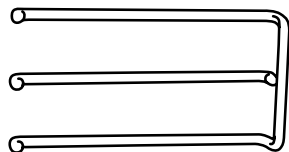

19149 thru 22149

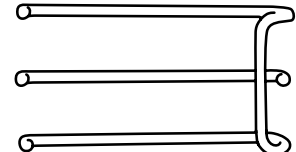

1156149 thru 1159149



PUSH/PULL PLATE

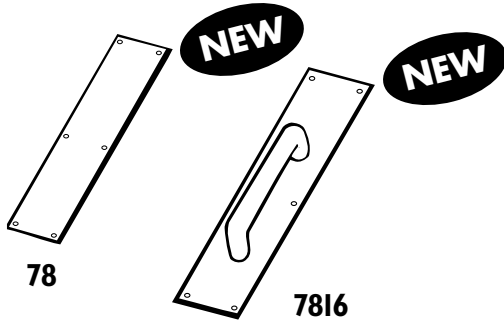

NUMBER	THICKNESS	DIMENSIONS	ANSI
78	.125	4" x 16"	J304
7816	.125	4" x 16"	J407

SHELF PACK: 1 Box Packaged

FINISHES: 630
10 (.125) Gauge

PUSH/PULL PLATE & CYLINDER PULL

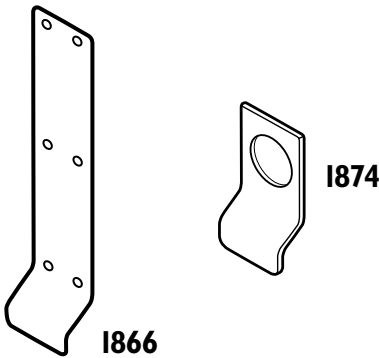

NUMBER	HOLE	DIMENSIONS	ANSI
1866	-	3 1/2" x 15 3/4"	J303
1874	1 1/4"	2" x 3 3/4"	J303

SHELF PACK: (1866) 1 Box Packaged
(1874) 10

FINISHES: 630
10 (.125) Gauge

FLUSH CUP PULLS

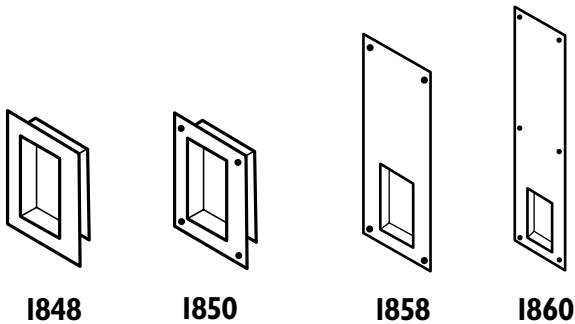

NUMBER	ANSI	DIMENSIONS
1848	J403	3 1/2" x 4 3/4"
1850	J403	3 1/2" x 4 3/4"
1858	J403	4" x 10"
1860	J403	4" x 16"

SHELF PACK: 10 Box Packaged

FINISHES: 630
16 (.062) Gauge

CABINET PULLS

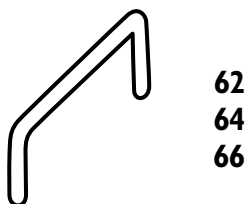

NUMBER	CTC	DIAMETER	ANSI
62	3"	5/16"	B22011
64	3 1/2"	5/16"	B22011
66	4"	5/16"	B22011

SHELF PACK: 10 Polybagged

FINISHES: 605, 625, 626
Includes both 1 1/4" and 2" screws

CABINET KNOB

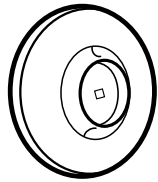

59

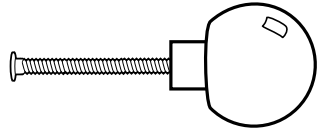

58

NUMBER	KNOB	BACK PLATE
58	1 1/4"	-
59	-	1 3/4"

SHELF PACK: 10
FINISHES: 605, 620, 625, 626

Polybagged

CABINET KNOB

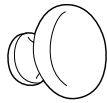

54
1 1/4"

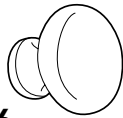

56
1 1/2"



NUMBER	ANSI
54	B12131
56	B12131

SHELF PACK: 10
FINISHES: 605, 613, 619, 620, 626
MATERIAL: Solid Brass

Polybagged

DISPLAY PACKAGED PUSH & PULL PLATES

PL-13515

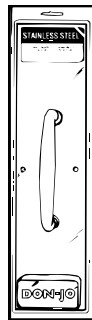

PS-13515

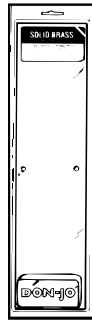

NUMBER	DIMENSIONS
PL-13515	3 1/2" x 15"
PS-13515	3 1/2" x 15"

SHELF PACK: 10
FINISHES: 605, 613, 630

Display Packaged Size - 4 1/4" x 17 1/4"
• Made of (.050) 18 gauge material

FASTENING METHODS FOR DOOR PULLS

1

Thru-Bolt

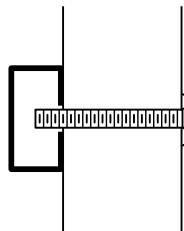

2

Surface
Concealed for
Wood Doors

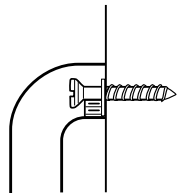

3

Back to Back
Base must
be at least
3/4" thick

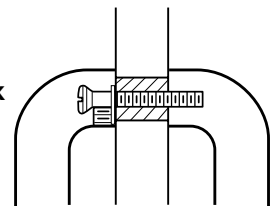

4

Decorative
Thru-Bolt
Glass Door

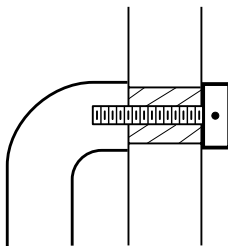

5

Back to Back
Glass Door
supplied with
5/8" Plexiglass
Sleeve with
Neoprene
Washers

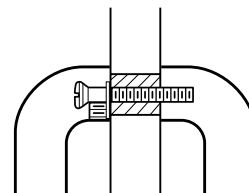

6

Surface Concealed
Base must be
at least 3/4" thick

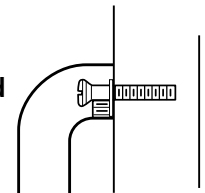

7

Back to back with
Two Concealed
studs welded to the
back of a Push Plate

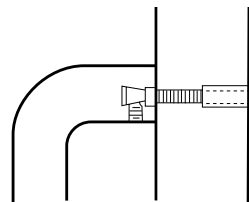



WROUGHT WALL BUMPERS

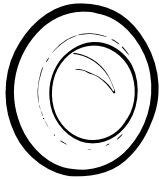

I406
2 1/2" Diameter

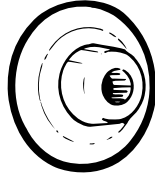

I407
2 1/2" Diameter

NUMBER	FASTENER	ANSI	MATERIAL
I406	Plastic Anchor & Plastic Dry Wall Anchor	L22101, L52101	Wrought
I407		L22251, L52251	Wrought

SHELF PACK: 50

Polybagged

FINISHES: (I406) 605, 606, 612, 613, 625, 626, 630
(I407) 605, 606, 612, 613, 619, 620, 625, 626, 630

Display Packaged Size - 4" x 6"
Available on I406 & I407

#I406 & #I407 display package available.
When ordering indicate by adding a "V"
before the item number.

CAST WALL BUMPERS

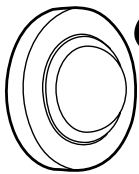

I412
2 1/2" Diameter

NEW

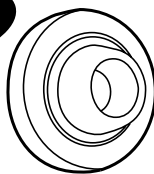

I413
2 1/2" Diameter

NEW

NUMBER	FASTENER	ANSI	MATERIAL
I412	Plastic Anchor & Plastic Dry Wall Anchor	L12101	Cast Brass
I413		L12251	Cast Brass

SHELF PACK: 10

Polybagged

FINISHES: 605, 613, 626

WALL BUMPERS



I400
1" Diameter



I401
1 13/16" Diameter

NEW

NUMBER	FASTENER	ANSI	MATERIAL
I400	Anchor & Screw	L12101	Cast Brass
I401	Adhesive	-	Rubber
I402	SMS & Plastic Anchor & Toggler	-	Solid Brass
I410	M/S & Exp. Shield	-	Cast Brass

SHELF PACK: (I400, I401) 50
(I402, I410) 10

Polybagged

FINISHES: (I400) 605, 606, 613, 625, 626
(I401) Gray, White
(I402, I410) 626

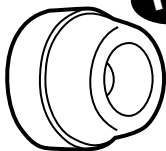

I402
1 1/2" Diameter

NEW

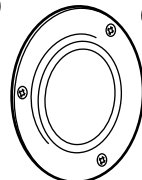

I410
3 7/8" Diameter

NEW

FLOOR STOPS

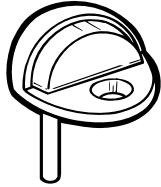

I440
Low Style
1/4" h x 1 5/8"
diam. base

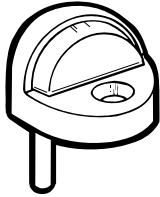

I442
High Style
1/2" h x 1 5/8"
diam. base



I446
1/2"

NUMBER	FASTENER	ANSI
I440	W/S & MS & Exp Shield & Plastic Anchor	L12141
I442		L12161
I446	Riser	-

SHELF PACK: (I440, I442) 20
(I446) 10

Polybagged
Packaged: (I440, I442)

FINISHES: (I440, I442) 605, 606, 612, 613, 619, 620, 625, 626
(I446) 605, 613, 625, 626

MATERIAL: Cast Brass

Display Packaged Size - 4" x 6"

I440 & I442
Display Packaged available.
When ordering indicate by
adding a "V" before the
item number.

FLOOR STOPS



I445
3/4" High x 1 5/8" Diameter Base
I440 and I446 combo pack

NUMBER	FASTENER
I445	W/S & MS & Exp Shield & Plastic Anchor

SHELF PACK: (I445) 20

Polybagged

FINISHES: (I445) 605, 613, 625, 626

MATERIAL: Cast Brass

FLOOR STOPS

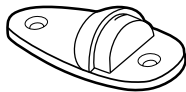

I443
1" High x 3/16"
Base thickness

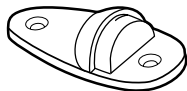

I444
3/8" High x 1/2"
Base thickness

NUMBER	FASTENER
I443	W/S & MS & Exp Shield & Plastic Anchor
I444	

SHELF PACK: (I443, I444) 10

Polybagged

FINISHES: (I443, I444) 605, 613, 626

MATERIAL: Cast Brass

DOOR STOPS

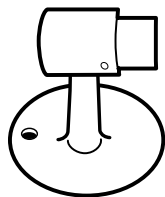

I471
2 1/4" base
3" projection

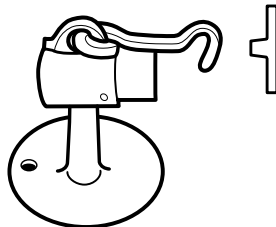

I473
2 1/4" base
3" projection

NUMBER	FASTENER	ANSI
I471	WS, MS, Exp. Shield & Plastic Anchor	LI2131
I473		LI1371
I475	WS, MS, Exp. Shield & Plastic Anchor	LI2021
I477		LI1351

SHELF PACK: 10
FINISHES: 605, 613, 626

Polybagged
MATERIAL: Cast Brass

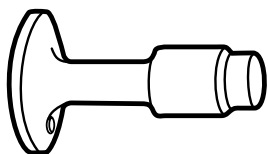

I475
2 1/4" base
3 1/2" projection

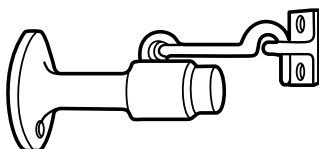

I477
2 1/4" base
3 1/2" projection

DOOR STOPS

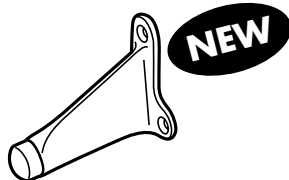

I490

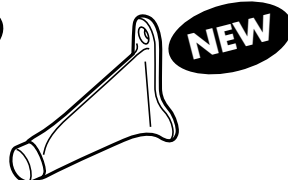

I492

NUMBER	DIMENSIONS	FASTENERS
I490	3 3/4" projection	W/S, M/S & Plastic Anchors
I492	3 3/4" projection	W/S, M/S, Exp. Shield

SHELF PACK: 10
FINISHES: 605, 613, 626

Polybagged
MATERIAL: Cast Brass

DOOR STOPS

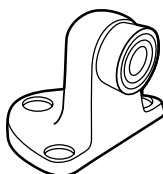

I448
1 5/8" projection
2 1/4" x 1 5/8" base

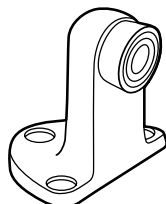

I449
2 1/2" projection
2 1/4" x 1 5/8" base

NUMBER	FASTENER
I448	W/S & Exp. Shield
I449	W/S & Exp. Shield

SHELF PACK: 10
FINISHES: 605, 613, 626

Polybagged
MATERIAL: Cast Brass



DOOR STOPS

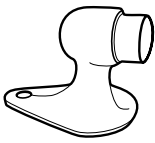

I450
2 1/8" projection
2 5/8" x 1 5/8" base

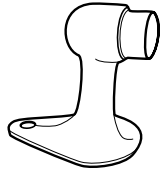

I452
2 3/4" projection
2 1/4" x 1 1/4" base

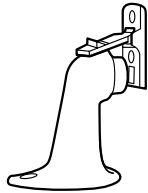

I453
2 3/4" projection
2 1/4" x 1 1/4" base

NUMBER	FASTENER	ANSI
I450	W/S & Exp. Shield	LI2131
I452	W/S & Exp. Shield	LI2131
I453	W/S & Exp. Shield	LI3171

SHELF PACK: 10

FINISHES: (I450, I452) 605, 613, 619, 620, 626
(I453) 605, 613, 626

MATERIAL: Cast Brass

Polybagged

ROLLER BUMPERS

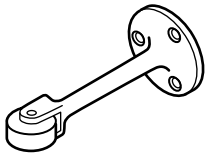

I486
4 1/2" projection

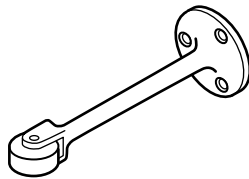

I487
6" projection

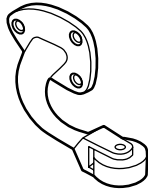

I488
2 3/4" projection

NUMBER	FASTENER	ANSI
I486	W/S or M/S	LI2211
I487	WS or M/S	LI2211
I488	W/S or M/S	LI2191

SHELF PACK: 10

FINISHES: 605, 613, 626

MATERIAL: Cast Brass

Polybagged

MATERIAL: Cast Brass

DETENTION STOP

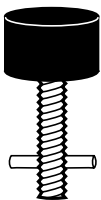

I462
Detention Stop
1 1/2" x 2 1/2"
(4" overall)

NUMBER	FASTENER
I462	Stop

SHELF PACK: 10

FINISHES: Black

Polybagged

DOOR HOLDERS

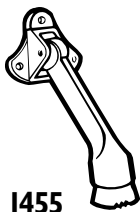

I455
Cast Aluminum
4" projection

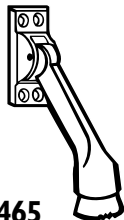

I465
Solid Brass
4" projection

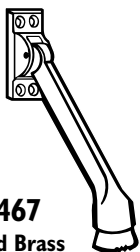

I467
Solid Brass
5" projection

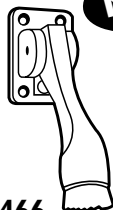

I466
Cast Iron
4" projection

NEW



I468
Rubber
Replacement Tip

NUMBER	FASTENER	ANSI
I455	SMS	L11382
I465	SMS	L11382
I466	SMS	-
I467	SMS	L11382
I468	Replacement Tip	-

SHELF PACK: (I455, I465, I466, I467) 20 (I468) 10 **Polybagged**

FINISHES: (I455) 626, BP (Brass Plated), BZ (Bronze Sprayed), CP (Chrome Plated), DU (Duro Coated)
(I465) 605, 613, 625, 626
(I466) Sprayed Brass, Sprayed Bronze, Sprayed Aluminum
(I467) 605, 613, 626
(I468) Gray Rubber

#I455 & #I465 display package available.
When ordering indicate by adding a "V" before the item number.

Display Packaged Size - 5 1/4" x 6 1/2"

DOOR HOLDER

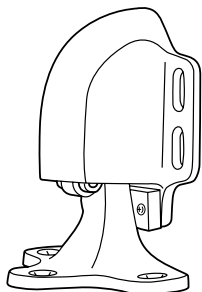

NEW

NUMBER	DOOR TO FLOOR CLEARANCE	HOLDER DIMENSIONS	ANSI
I520	1/2" or less	3" W x 3" H	L11301
I521	9/16" - 1 1/16"	3" W x 3" H	L11301
I522	1 1/8" - 1 9/16"	3" W x 3" H	L11301
I523	1 5/8" - 2 1/16"	3" W x 3" H	L11301

SHELF PACK: 1
FINISHES: 605,606,613,626
MATERIAL: Cast Brass

Box Pack

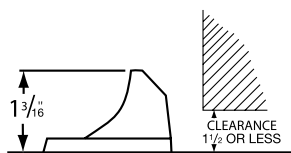

I520

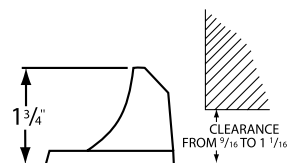

I521

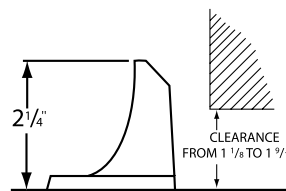

I522

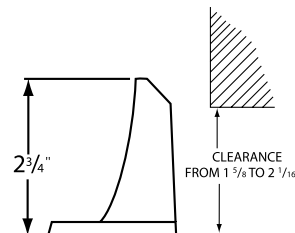

I523



DOOR HOLDER

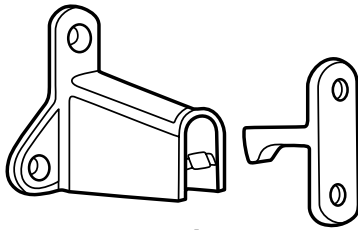

1514

NUMBER	PROJECTION	DIMENSIONS	ANSI
1514	3 1/2"	2" x 2 1/4"	L11291

SHELF PACK: 1
FINISHES: 626

Polybagged
MATERIAL: Cast Brass

ANGLE STOP

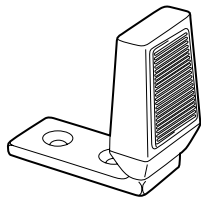

NEW

1480

NUMBER	DIMENSIONS
1480	2 3/4" x 1 1/2" x 2 5/8"

SHELF PACK: 10
FINISHES: 626

Polybagged

RIGID BASE STOPS

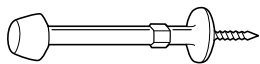

1501



1504

NEW



1506

NUMBER	MATERIAL	PROJECTION	ANSI
1501	Cast Zinc	3"	L32031
1504	Cast Aluminum	3"	L32031
1506	Cast Brass	3 1/4"	L12031

SHELF PACK: (1501, 1504) 50 Polybagged
(1506) 10

FINISHES: (1501) 605, 609, 625
(1504, 1506) 605, 613, 619, 620, 625, 626

SPRING BASE STOPS



1508

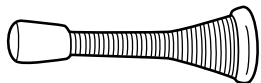

1509

1510

NUMBER	MATERIAL	PROJECTION
1508	Spring Base	3"
1509	Spring Base	3 1/8"
1510	Spring Base	3 3/4"

SHELF PACK: 50
FINISHES: 605, 609, 619, 620, 625

Polybagged

HINGE STOP

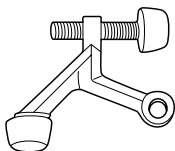

1500

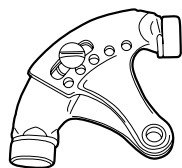

1502

NEW

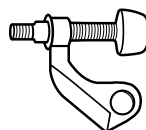

1503

NEW

NUMBER	MATERIAL
1500	Cast Zinc
1502	Cast Brass
1503	Cast Brass

Polybagged

SHELF PACK: (1500) 100, (1502, 1503) 20
FINISHES: (1500) 605, 619, 620, 625
(1502) 605, 613, 619, 620, 626
(1503) 605, 609, 619, 620, 625

DOOR SILENCERS



1608
For metal frame

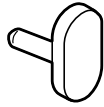

1609
For wood frame



1610
Adhesive mounting

NUMBER	ANSI
1608	L03011
1609	L03021
1610	-

SHELF PACK: 100 Polybagged
FINISHES: Gray Rubber
(1610 also available in clear)

DOOR STOPS

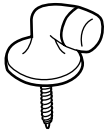

1430
Base: 1 1/4"
Height: 1 5/16"



1432
Base: 1 1/4"
Height: 1 5/16"



NUMBER	MATERIAL	FASTENER	ANSI
1430	Cast Brass	SMS	-
1432	Cast Aluminum	-	L32181

SHELF PACK: (1430) 10, (1432) 50 Polybagged
FINISHES: 605, 613, 619, 620, 626

APPLIED STOP

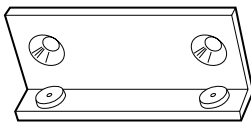

1420

NUMBER	DIMENSIONS
1420	1 1/2" x 3/4" x 3 1/2"

SHELF PACK: 10 Polybagged
FINISHES: 605, 613, 626 7 (.1875) Gauge
• For use with single or double doors without stops
• Supplied with machine & wood screws



FLUSH BOLTS

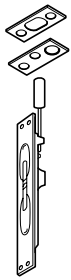

1555
UL rated
For metal doors

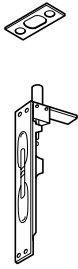

1557
UL rated
For wood doors

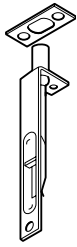

1640
1" bolt throw
1/2" bolt diameter
For wood doors

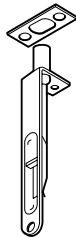

1640R

NUMBER	DIMENSIONS	ANSI
1555	6 3/4" x 1"	L14251, L14081
1557	6 3/4" x 1"	-
1640	6" x 3/4"	L04201
1640R	6" x 3/4"	L04201



SHELF PACK: 10 **Box Packaged**

FINISHES: (1555) 605, 612, 613, 625, 626
(1557) 605, 612, 613, 625, 626
(1640, 1640R) 605, 609, 613, 619, 620, 626

(1555 Longer rods available, contact factory.)
Packaged and sold individually

AUTOMATIC FLUSH BOLTS

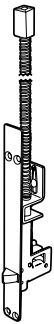

1560
UL Rating for
Metal Doors

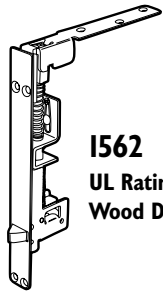

1562
UL Rating for
Wood Doors



NUMBER	DIMENSIONS
1560	6 3/4" x 1"
1562	8 1/2" x 1"



SHELF PACK: 10 **Box Packaged**
FINISHES: 605, 613, 626

Conforms to UL 10C

* Auto Flush Bolts are packaged and sold in pairs

ALUMINUM FLUSH BOLT



1550



1551

NUMBER	DIMENSIONS	OFFSET
1550	15/16" x 4 1/4"	1/8"
1551	Radius Face	1/4"

SHELF PACK: 4 **Box Packaged**
FINISHES: SL, DU

DUST PROOF STRIKES

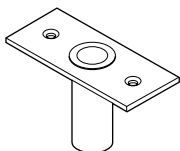

1570

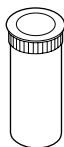

1572

NUMBER	DIMENSIONS	ANSI
1570	2 7/8" x 1 3/4"	L24021
1572	15/16" Diameter	L24021

SHELF PACK: 10 **Polybagged**
FINISHES: 605, 613, 626

ROLLER LATCHES

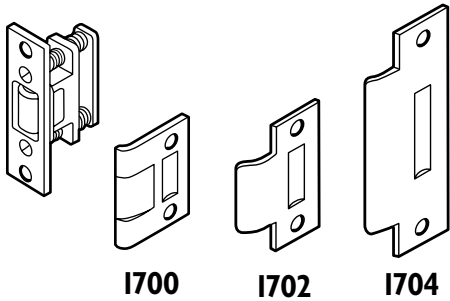

NUMBER	SIZE	STRIKE	ANSI
1700	3 3/8" x 1"	1 11/16" x 2 1/4"	-
1702	3 3/8" x 1"	1 3/4" x 2 3/4"	-
1704	3 3/8" x 1"	1 1/4" x 4 7/8"	E19091

SHELF PACK: 10
FINISHES: 605, 613, 619, 620, 626

Polybagged
MATERIAL: Cast Brass

BALL LATCHES

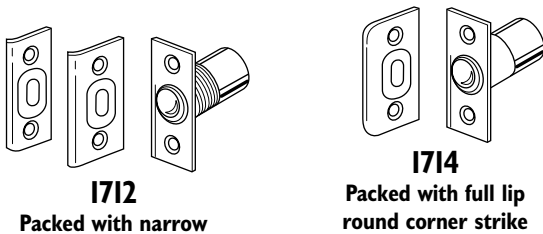

1712
Packed with narrow and wide strike.
Adjustable

1714
Packed with full lip round corner strike

NUMBER	DIMENSIONS	MATERIAL
1712	2 1/8" x 1"	Cast Brass
1714	2 1/4" x 1"	Cast Aluminum
1716	1"	Cast Brass

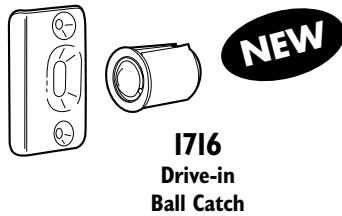

1716
Drive-in Ball Catch

SHELF PACK: 20
FINISHES: (1712) 605, 613, 619, 620, 626
(1714) 605, 609
(1716) 605, 609, 613, 619, 620, 626

Polybagged

MAGNETIC CATCHES

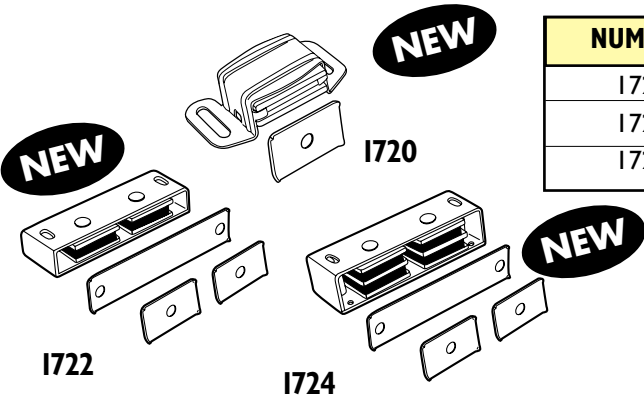

NUMBER	DIMENSIONS	LOAD CAPACITY	ANSI
1720	2 1/16" x 1 1/8" x 5/8"	5 lbs.	-
1722	3 1/8" x 1" x 9/16"	9 lbs.	B43161
1724	3 1/8" x 1" x 3/4"	14 lbs.	B43161

SHELF PACK: 10
FINISHES: 605, 626

Polybagged

SLIDE BOLTS

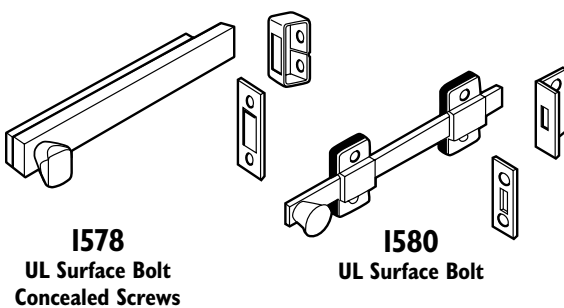

1578
UL Surface Bolt
Concealed Screws

1580
UL Surface Bolt

NUMBER	DIMENSIONS	ANSI
1578	8"	L84161
1580	8"	L84161

SHELF PACK: 10
FINISHES: 626
• Furnished with Rim and Mortise strikes

Polybagged
MATERIAL: Solid Brass



SLIDE BOLTS

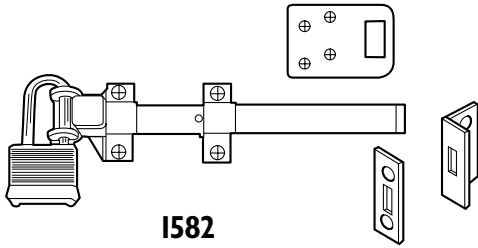

1582

NUMBER	DIMENSIONS	THROW
1582	8"	1"

SHELF PACK: 10
FINISHES: 626, 630

Polybagged
MATERIAL: Stainless Steel

- All stainless steel components
- Top and bottom strikes available
- Padlock not included

SLIDE BOLTS

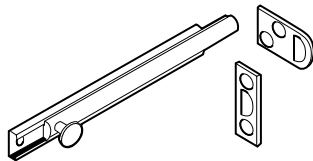

SB-2
SB-3
SB-4
SB-6
SB-12

NUMBER	DIMENSIONS	ANSI
SB-2	2"	L0415 I
SB-3	3"	L0415 I
SB-4	4"	L0415 I
SB-6	6"	L0415 I
SB-12	12"	L0415 I

SHELF PACK: 10
FINISHES: (SB-2, SB-3) 605, 613, 609, 625, 626
(SB-4, SB-6, SB-12) 605, 613, 609, 619, 620, 625, 626

Polybagged
MATERIAL: Solid Brass

- Furnished with Rim and Mortise strikes

DUTCH DOOR BOLTS

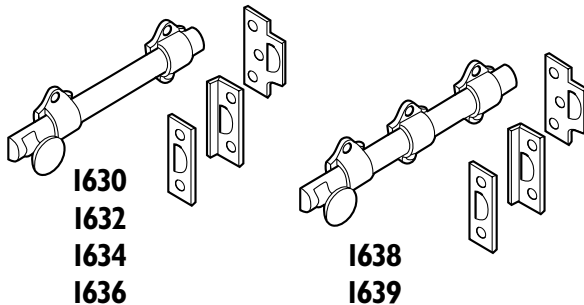

1630
1632
1634
1636

1638
1639

NUMBER	DIMENSIONS	BOLT
1630	4 1/2" x 1 5/8"	5/8" Half Round
1632	8" x 1 5/8"	5/8" Half Round
1634	12" x 1 5/8"	5/8" Half Round
1636	18" x 1 5/8"	5/8" Half Round
1638	24" x 1 5/8"	5/8" Half Round
1639	36" x 1 5/8"	5/8" Half Round

SHELF PACK: 10
FINISHES: 605, 613, 619, 620, 625, 626

Polybagged
MATERIAL: Solid Brass



DON-JO MFG., INC.

COORDINATORS SERIES

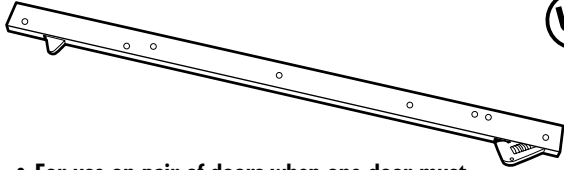

- For use on pair of doors when one door must close before the other
- Safety override allows active door to close first when extreme force applied
- Filler bar available when coordinator does not fill entire length of opening
- Mounting brackets available when stop mounted hardware used

UL	DOOR FRAME OPENING	MODEL NUMBER	INCLUDES COORDINATOR	INCLUDES FILLER BAR
	52" or less	2011	2010 (32")	2001 (20")
	52 1/16" to 56"	2012	2010 (32")	2002 (32")
	56 1/16" to 72"	2021	2020 (52")	2001 (20")
	72 1/16" to 84"	2022	2020 (52")	2002 (32")
	84 1/16" to 96"	2023	2020 (52")	2003 (44")
	96 1/16" to 104"	2033	2030 (60")	2003 (44")
	over 104"	Contact Factory		

SHELF PACK: I

Box Packed

UNIVERSAL COORDINATOR

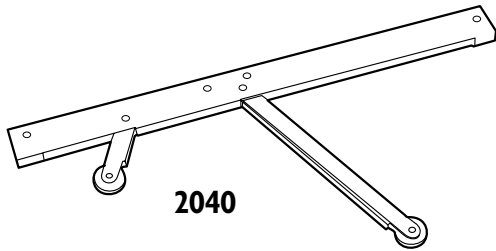

2040

UL	NUMBER	FINISH
	2040	Matte Black

Box Packed

SHELF PACK: I
FINISHES: 622

- One size for all pairs of doors up to 8' wide
- Non-handed • Stop mounted
- Meets ANSI I56.3, Type 21 requirements (when used with carry bar)
- Mounting brackets not required when using stop mounted hardware

MOUNTING BRACKETS

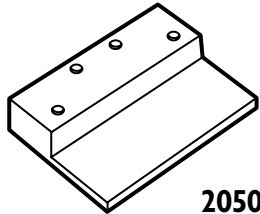

2050

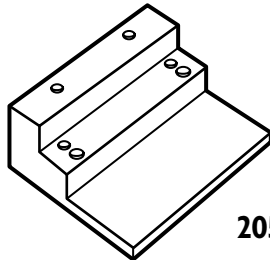

2051

NUMBER	STOP WIDTHS
2050	over 2 1/2"
2051	up to 2 1/2"

SHELF PACK: I

Box Packed

- For stop mounted hardware
- Ready to paint aluminum, plated finishes available

CARRY BAR

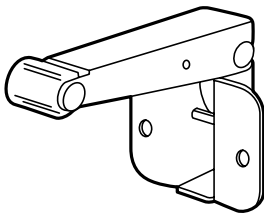

2060

NUMBER
2060

SHELF PACK: I

Box Packed

- For pair of doors, where inactive door can be opened before active door
- Mounted on inactive door
- USP standard, plated finishes available

GRAVITY COORDINATOR

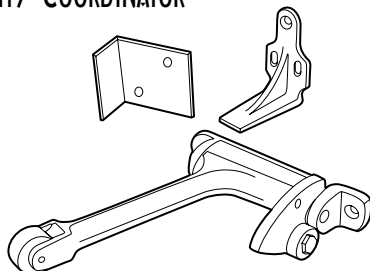

2080

UL	NUMBER
	2080

SHELF PACK: I

Box Packed

- Drop arm type
- Adjustable

HEAVY-DUTY CRASH CHAINS

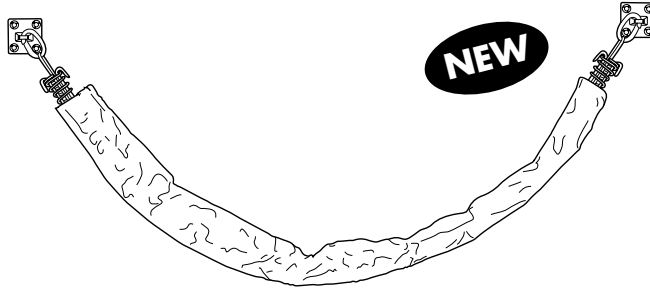

Gray Vinyl Cover

NUMBER	SIZE	ANSI
HDCC-2012	20 1/2"	LB2231
HDCC-2512	25 1/2"	LB2231
HDCC-3012	30 1/2"	LB2231

SHELF PACK: 10
FINISHES: 626

Polybagged

Available with thru bolts, Contact factory

CONCEALED STOP

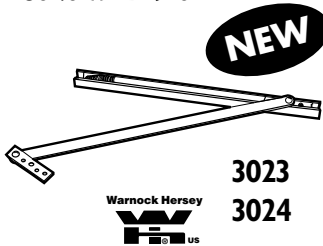

3023
3024

NUMBER	DOOR OPENING		DOOR SIZE	ANSI
	BUTTS	CENTER HUNG		
3023	30" to 35 15/16"	32" to 37 15/16"	30"	C04541
3024	35" to 48"	38" to 48"	36"	C04541

SHELF PACK: 1
Non Handed Medium-duty overhead stop
For interior door, single or double acting

Box Pack

FINISHES: 630
MATERIAL: Stainless Steel

SURFACE STOP

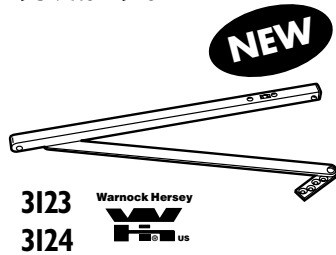

3123
3124

NUMBER	DOOR OPENING		DOOR SIZE	ANSI
	BUTTS	CENTER HUNG		
3123	30" to 35 15/16"	33 1/2" to 38 15/16"	30"	C05541
3124	36" to 48"	39" to 48"	36"	C05541

SHELF PACK: 1
Non Handed Medium-Duty overhead stop
For interior door, single acting

Box Pack

FINISHES: 630
MATERIAL: Stainless Steel

SURFACE HOLDER

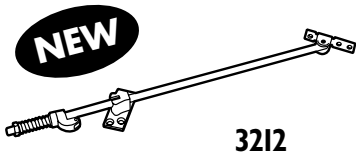

3212

NUMBER	DOOR OPENING		FASTENERS	ANSI
	BUTTS	CENTER HUNG		
3212	35" to 40 15/16"	38 1/2" to 44 3/16"	W/S & M/S	C08511

SHELF PACK: 1
Heavy-duty overhead door holder
For exterior, vestibule and interior doors, single acting

Box Pack

FINISHES: 630
MATERIAL: Stainless Steel

SURFACE STOP

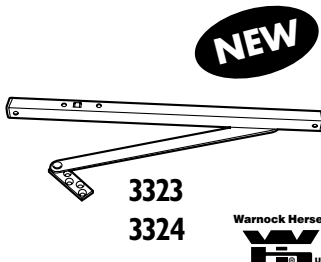

3323
3324

NUMBER	DOOR OPENING		DOOR SIZE	ANSI
	BUTTS	CENTER HUNG		
3323	32" to 35 15/16"	36" to 38 15/16"	30"	C02541
3324	36" to 39 15/16"	39" to 40 15/16"	36"	C02541

SHELF PACK: 1
Non Handed Heavy-duty overhead door stop
For exterior, vestibule or interior doors, single acting

Box Pack

FINISHES: 630
MATERIAL: Stainless Steel

HOSPITAL LATCH

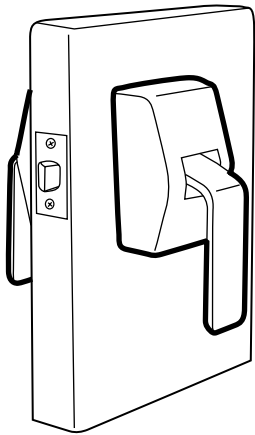

NEW

4500
4550



NUMBER	BACK SET	DOOR
4500	2 ³ / ₄ "	1 ³ / ₄ " to 2 ¹ / ₄ "
4550	5"	1 ³ / ₄ " to 2 ¹ / ₄ "

SHELF PACK: 1
FINISHES: 626

Box Packed

- Packed with ANSI strike and T strike as standard
- Lever projection 3¹/₄"
- Bolt 1/2" throw with anti-friction nylon insert

- Non-handed (except for engraved models).
When ordering engraved models, add the letter P after the item number and designate hand.
- Push/pull latch can be mounted with the handles up, down or horizontal without any modification.
- UL listed for all fire doors.
- Meets ADA requirements

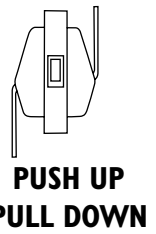
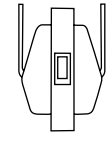
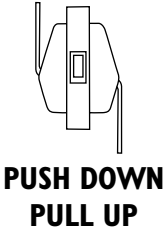
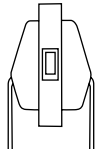
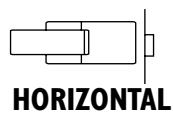
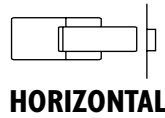



CLASSIC WRAP-AROUNDS

The Classic Wrap-Around advantage includes:

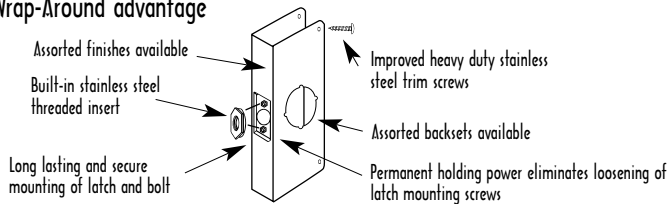

- Finishes Available:
 605= Polished Brass
 609= Antique Brass
 612= Satin Bronze
 613= Oil Rubbed Bronze
 630= Stainless Steel

Note: Security Strikes are recommended with these products. See Pages 51,52 for ordering instructions.

For **CYLINDRICAL DOOR LOCKS** with 2 1/8" hole

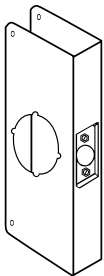

- 1-CW**
2-CW
3-CW
4-CW

NUMBER	BACKSET	DOOR	DIMENSIONS
1-CW	2 3/8"	1 3/8"	4" x 9"
2-CW	2 3/8"	1 3/4"	4" x 9"
3-CW	2 3/4"	1 3/8"	4 1/4" x 9"
4-CW	2 3/4"	1 3/4"	4 1/4" x 9"

SHELF PACK: 1

FINISHES: PB (605), AB (609), BZ (612), IOB (613), S (630)

22 (.032) Gauge

Box Size - 4 1/2" x 9 3/4"

CW comes box packaged as standard.

Display Packaged also available. When ordering indicate by replacing the letters "CW" with "V" after the item number.

Display Package Size - 5 1/4" x 11"

For **DEADBOLTS** with 1 1/2" hole

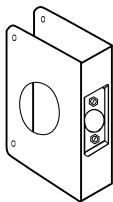

- 5-CW**
6-CW
7-CW
8-CW

NUMBER	BACKSET	DOOR	DIMENSIONS
5-CW	2 3/8"	1 3/8"	4" x 4 1/2"
6-CW	2 3/8"	1 3/4"	4" x 4 1/2"
7-CW	2 3/4"	1 3/8"	4 1/4" x 4 1/2"
8-CW	2 3/4"	1 3/4"	4 1/4" x 4 1/2"

SHELF PACK: 1

FINISHES: PB (605), AB (609), BZ (612), IOB (613), S (630)

22 (.032) Gauge

Box Size - 5 1/4" x 4 1/2"

CW comes box packaged as standard.

Display Packaged also available. When ordering indicate by replacing the letters "CW" with "V" after the item number.

Display Package Size - 5 1/4" x 6 1/2"

For **CYLINDRICAL DOOR LOCKS** with 2 1/8" hole

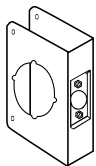

- 51-CW**
61-CW
71-CW
81-CW

NUMBER	BACKSET	DOOR	DIMENSIONS
51-CW	2 3/8"	1 3/8"	4" x 4 1/2"
61-CW	2 3/8"	1 3/4"	4" x 4 1/2"
71-CW	2 3/4"	1 3/8"	4 1/4" x 4 1/2"
81-CW	2 3/4"	1 3/4"	4 1/4" x 4 1/2"

SHELF PACK: 1

FINISHES: PB (605), AB (609), BZ (612), IOB (613), S (630)

22 (.032) Gauge

Box Size - 5 1/4" x 4 1/2"

CW comes box packaged as standard.

Display Packaged also available. When ordering indicate by replacing the letters "CW" with "V" after the item number.

Display Package Size - 5 1/4" x 6 1/2"



For DOUBLE LOCK COMBINATION LOCKSETS with 1 1/2" hole on top and 2 1/8" hole on bottom with 4" centers

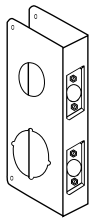

**154-CW
264-CW
484-CW**

NUMBER	BACKSET	DOOR	DIMENSIONS
154-CW	2 3/8"	1 3/8"	4" x 9"
264-CW	2 3/8"	1 3/4"	4" x 9"
484-CW	2 3/4"	1 3/4"	4 1/4" x 9"

Display Packaged also available. When ordering indicate by replacing the letters "CW" with "V" after the item number.

Display Package Size - 5 1/4" x 11"

SHELF PACK: I

FINISHES: PB (605), AB (609), BZ (612), IOB (613), S (630)

22 (.032) Gauge

Box Size - 4 1/2" x 9 3/4"

CW comes box packaged as standard.

For DOUBLE LOCK COMBINATION LOCKSETS with 2 1/8" holes with 5 1/2" centers

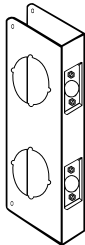

**256-CW
258-CW**

NUMBER	BACKSET	DOOR	DIMENSIONS
256-CW	2 3/8"	1 3/4"	4" x 12"
258-CW	2 3/4"	1 3/4"	4 1/4" x 12"

SHELF PACK: I

FINISHES: PB (605), AB (609), BZ (612), IOB (613), S (630)

22 (.032) Gauge

Box Packed Only

For CYLINDER DOOR LOCKS with 2 1/8" hole, 12" height

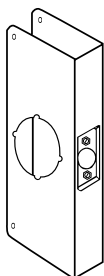

12-CW

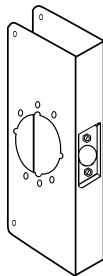

12-2-CW

NUMBER	BACKSET	DOOR	DIMENSIONS
12-CW	2 3/4"	1 3/4"	4 1/4" x 12"
12-2-CW	2 3/4"	1 3/4"	4 3/4" x 12"

SHELF PACK: I

FINISHES: PB (605), S (630)

22 (.032) Gauge

Box Packed Only

For DOUBLE LOCK COMBINATION LOCKSETS with 2 1/8" holes with 3 5/8" centers

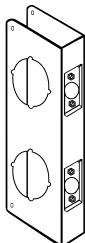

**151-CW
261-CW
481-CW**

NUMBER	BACKSET	DOOR	DIMENSIONS
151-CW	2 3/8"	1 3/8"	4" x 9"
261-CW	2 3/8"	1 3/4"	4" x 9"
481-CW	2 3/4"	1 3/4"	4 1/4" x 9"

Display Packaged also available. When ordering indicate by replacing the letters "CW" with "V" after the item number.

Display Package Size - 5 1/4" x 11"

SHELF PACK: I

FINISHES: PB (605), AB (609), BZ (612), IOB (613), S (630)

22 (.032) Gauge

Box Size - 4 1/2" x 9 3/4"

CW comes box packaged as standard.



For DOUBLE LOCK COMBINATION LOCKSETS with 2 1/8" holes with 4" centers

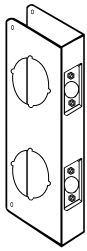

942-CW
943-CW

NUMBER	BACKSET	DOOR	DIMENSIONS
942-CW	2 3/8"	1 3/4"	4" x 9"
943-CW	2 3/4"	1 3/4"	4 1/4" x 9"

SHELF PACK: I

FINISHES: PB (605), AB (609), BZ (612), IOB (613), S (630)

22 (.032) Gauge

Box Size - 4 1/2" x 9 3/4"

CW comes box packaged as standard.

Display Packaged also available. When ordering indicate by replacing the letters "CW" with "V" after the item number.

Display Package Size - 5 1/4" x 11"

For DOUBLE LOCK COMBINATION LOCKSETS with 6" centers

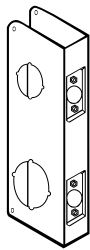

486-CW
hole sizes
1 1/2" over 2 1/8"

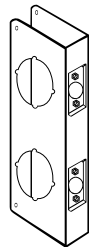

946-CW
hole sizes
2 1/8" over 2 1/8"

NUMBER	BACKSET	DOOR	DIMENSIONS
486-CW	2 3/4"	1 3/4"	4 1/2" x 12"
946-CW	2 3/4"	1 3/4"	4 1/2" x 12"

SHELF PACK: I

FINISHES: PB (605), S (630)

22 (.032) Gauge

Box Packed Only

BLANK WRAP-AROUND with TRIM SCREWS

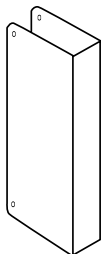

30-CW
40-CW
70-CW
80-CW
90-CW

NUMBER	DOOR	DIMENSIONS
30-CW	1 3/8"	4 1/4" x 9"
40-CW	1 3/4"	4 1/4" x 9"
70-CW	1 3/8"	4 1/4" x 4 1/2"
80-CW	1 3/4"	4 1/4" x 4 1/2"
90-CW	1 3/4"	5" x 12"

SHELF PACK: I

FINISHES: PB (605), AB (609), BZ (612), IOB (613), S (630)

22 (.032) Gauge

Box Size - 5 1/4" x 4 1/2" and 4 1/2" x 9 3/4"

CW comes box packaged as standard.

90-CW Box Packed Only

Display Packaged also available. When ordering indicate by replacing the letters "CW" with "V" after the item number.

Display Package Size - 5 1/4" x 11" and 5 1/4" x 6 1/2"

20" WRAP-AROUND

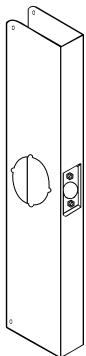

20-CW



20B-CW

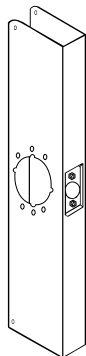

20-2-CW

NUMBER	BACKSET	DOOR	DIMENSIONS
20-CW	2 3/4"	1 3/4"	5" x 20"
20B-CW	-	1 3/4"	5" x 20"
20C-CW	2 3/8"	1 3/4"	5" x 20"
20-2-CW	2 3/4"	1 3/4"	5 3/4" x 20"

SHELF PACK: I

FINISHES: PB (605), S (630)

22 (.032) Gauge

Box Packed Only

- Beveled front
- Non-handed



For installing the **MARKS LEVERS & MEDECO LEVERS**

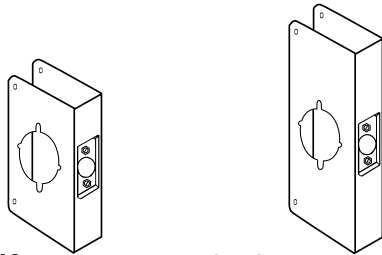

75-CW

95-CW

NUMBER	BACKSET	DOOR	DIMENSIONS
75-CW	2 3/4"	1 3/4"	4 3/4" x 5 1/2"
95-CW	2 3/4"	1 3/4"	4 3/4" x 9"

SHELF PACK: I **Box Packed Only**
FINISHES: PB (605), AB (609), BZ (612), S (630)
 22 (.032) Gauge

For installing the **BEST 93K LEVER LOCK, 73K LOCKSET, SARGENT 6500 SERIES**

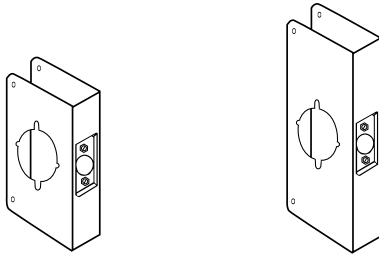

5K-CW

9K-CW

NUMBER	BACKSET	DOOR	DIMENSIONS
5K-CW	2 3/4"	1 3/4"	4 3/4" x 5 1/2"
9K-CW	2 3/4"	1 3/4"	4 3/4" x 9"

SHELF PACK: I **Box Packed Only**
FINISHES: PB (605), AB (609), BZ (612), S (630)
 22 (.032) Gauge

For use with **HEAVY DUTY GRADE 1 & GRADE 2 key-in-levers**

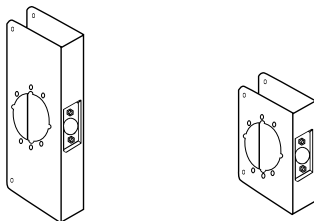

4-2-CW

81-2-CW

NUMBER	BACKSET	DOOR	DIMENSIONS
4-2-CW	2 3/4"	1 3/4"	4 3/4" x 9"
81-2-CW	2 3/4"	1 3/4"	4 3/4" x 4 1/2"

SHELF PACK: I **Box Packed Only**
FINISHES: (4-2-CW) PB (605), BZ (612), S (630)
(81-2-CW) PB (605), AB (609), BZ (612), S (630)
 22 (.032) Gauge

- Works with Schlage Rhodes, Arrow Sierra, Yale Augusta, Sargent 10-Line, Corbin Russwin 3300 & 3600, Falcon T and B Series and Lori Retrofit Kit

Fits **SIMPLEX/UNICAN 1000 SERIES & 4000 SERIES**

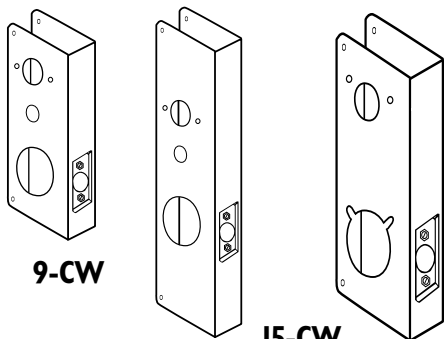

9-CW

15-CW

4000-CW

NUMBER	BACKSET	DOOR	DIMENSIONS
9-CW	2 3/4"	1 3/4"	5" x 9"
15-CW	2 3/4"	1 3/4"	5" x 15"
4000-2-CW	2 3/8"	1 3/4"	5" x 15"
4000-4-CW	2 3/4"	1 3/4"	5" x 15"

SHELF PACK: I **Box Packed Only**
FINISHES: PB (605), AB (609), S (630)
 22 (.032) Gauge



Fits ALARM LOCK 2700/T2 & 3000 SERIES TRILOGY LOCK

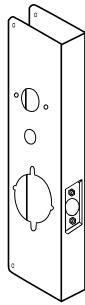

27-CW

NUMBER	BACKSET	DOOR	DIMENSIONS
27-CW	2 3/4"	1 3/4"	5" x 15"

SHELF PACK: 1 Box Packed Only
 FINISHES: PB (605), AB (609), S (630)
 22 (.032) Gauge

Fits BEST 93-KV LOCKS & MAS-HAMILTON POWER LEVERS

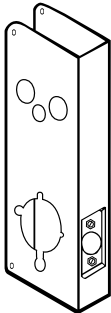

93-KV-CW

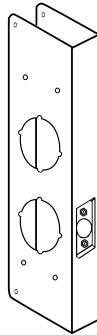

16-CW

NUMBER	BACKSET	DOOR	DIMENSIONS
93-KV-CW	2 3/4"	1 3/4"	5 1/2" x 12 3/4"
16-CW	2 3/4"	1 3/4"	5" x 15"

SHELF PACK: 1 Box Packed Only
 FINISHES: PB (605), AB (609), S (630)
 22 (.032) Gauge

Fits SCHLAGE COBRA LOCKS

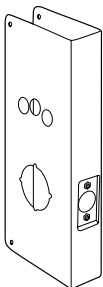

17-CW

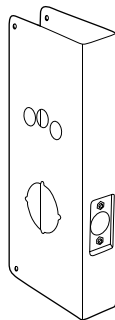

18-CW

NUMBER	BACKSET	DOOR	DIMENSIONS
17-CW	2 3/4"	1 3/4"	5" x 12"
18-CW	2 3/4"	1 3/4"	5" x 15"

SHELF PACK: 1 Box Packed Only
 FINISHES: 605, 612, 613, 630
 22 (.032) Gauge

Fits MARKS I-Q LOCKS

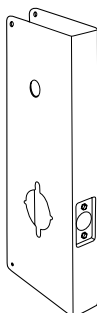

19-CW

NUMBER	BACKSET	DOOR	DIMENSIONS
19-CW	2 3/4"	1 3/4"	5" x 15"

SHELF PACK: 1 Box Packed Only
 FINISHES: 605, 613, 630
 22 (.032) Gauge



For conversion of **SIMPLEX 1000 SERIES & ALARM LOCK DL2500, 2700/T2 & 3000 SERIES** to key-in-knob lock

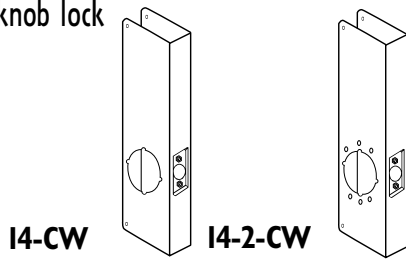

14-CW **14-2-CW**

NUMBER	BACKSET	DOOR	DIMENSIONS
14-CW	2 3/4"	1 3/4"	5" x 14"
14-2-CW	2 3/4"	1 3/4"	5" x 14"

SHELF PACK: I **Box Packed Only**
FINISHES: PB (605), AB (609), S (630)
 22 (.032) Gauge

MORTISE LOCK wrap-around plate for 86 cut-out

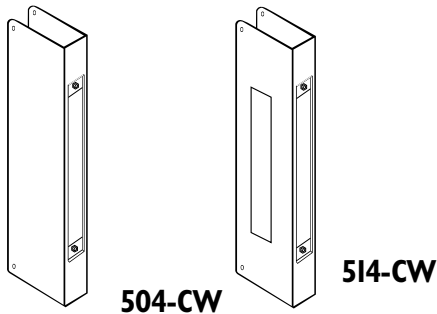

504-CW **514-CW**

NUMBER	BACKSET	DOOR	DIMENSIONS
504-CW	—	1 3/4"	5" x 12"
514-CW	2 3/4"	1 3/4"	5" x 12"

SHELF PACK: I **Box Packed Only**
FINISHES: PB (605), BZ (612), S (630)
 22 (.032) Gauge

- 8" x 1 1/4" Recess
- Drill spindle and thumb turn holes in field
- Rectangle size 1 5/8" x 7 5/16"
- 8" x 1 1/4" Recess

For LOCKS with **EXTENDED** or **CONVERTED BACKSETS**

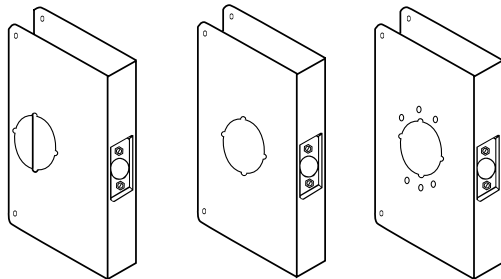

Extended 33-CW **Converted 33A-CW** **Converted 33A-2-CW**
55-CW **55A-CW** **55A-2-CW**

NUMBER	BACKSET	DOOR	DIMENSIONS
33-CW	3 3/4"	1 3/4"	5 1/2" x 9"
33A-2-CW	2 3/4"	1 3/4"	6 1/2" x 9"
33A-CW	2 3/4"	1 3/4"	6 1/2" x 9"
55-CW	5"	1 3/4"	6 1/2" x 9"
55A-2-CW	2 3/4"	1 3/4"	6 1/2" x 9"
55A-CW	2 3/4"	1 3/4"	6 1/2" x 9"

SHELF PACK: I **Box Packed Only**
FINISHES: PB (605), AB (609), BZ (612), S (630)
 22 (.032) Gauge

For **THICKER DOORS**

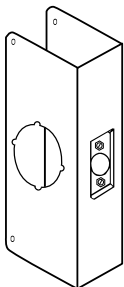

200-CW
200C-CW
212-CW
212C-CW
214-CW
214C-CW

NUMBER	BACKSET	DOOR	DIMENSIONS
200-CW	2 3/4"	2"	4 1/4" x 9"
200C-CW	2 3/8"	2"	4 1/4" x 9"
212-CW	2 3/4"	2 1/2"	4 1/4" x 9"
212C-CW	2 3/8"	2 1/2"	4 1/4" x 9"
214-CW	2 3/4"	2 1/4"	4 1/4" x 9"
214C-CW	2 3/8"	2 1/4"	4 1/4" x 9"

SHELF PACK: I **Box Packed only**
FINISHES: PB (605), S (630)
 22 (.032) Gauge

- Latch hole centered in door
- Available with lever Prep. - Custom order only



DOOR REINFORCER for deadbolts & key-in-knob locks

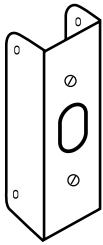

10-FE
20-FE

NUMBER	BACKSET	DOOR	DIMENSIONS
10-FE	-	1 3/8"	4 1/2" x 1"
20-FE	-	1 3/4"	4 1/2" x 1"

SHELF PACK: 10
FINISHES: PB (605), AB (609), S (630)
22 (.032) Gauge

Display Package Size - 4" x 7 3/4"

MORTISE LOCK wrap-around plate for 86 cut-out



504-FE

NUMBER	BACKSET	DOOR	DIMENSIONS
504-FE	-	1 3/4"	12" x 1"

SHELF PACK: 1
FINISHES: S (630)
22 (.032) Gauge
• 8" x 1 1/4" Recess

Box Packed Only

INTERIOR WRAP-AROUNDS

DON-JO MFG., INC. offers a line of Interior Wrap-Arounds. Each is manufactured from high quality prefinished steel brass plated material and is recommended for INTERIOR use only.

Available for: 1, 2, 3, 4, 5, 6, 7, 8, 51, 61, 71, 81, 30, 40, 70, 80, 154, 264, 484, 151, 261, 481, 258, 942, 943

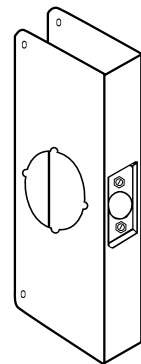

How to Order:
ie: 1-PB-IW

FLAT FRONT WRAP-AROUNDS

DON-JO MFG., INC. also offers a complete line of "original" Flat Front Wrap-Arounds. They are perfect for repairing, reinforcing or remodeling doors. Speed nuts are supplied with all Flat Front Wrap-Arounds and can be used in certain conditions when door is severely damaged or when replacing a mortise lock.

Available for: 1, 2, 3, 4, 5, 6, 7, 8, 51, 61, 71, 81, 30, 40, 70, 80, 154, 264, 484, 151, 261, 481, 258, 942, 943

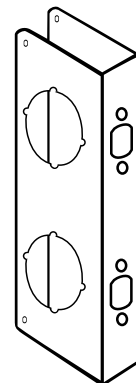
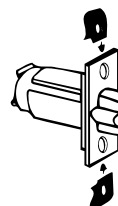

How to Order:
ie: 1-PB-VF



The INTERLOCK for inswinging doors

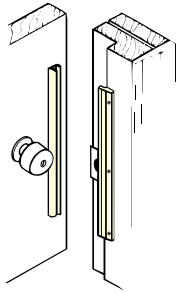

ILP-206
ILP-212

NUMBER	DIMENSIONS
ILP-206	6"
ILP-212	12"

SHELF PACK: 10 Display Package Size - 4" x 12" and 4" x 16"
FINISHES: BP (Brass Plated), DU (Duro Coated), SL (Silver Coated)
14 (.075) Gauge Steel

- 6" version for use with key-in-knob and deadbolt locks
- 12" version for use with Mortise Locks, Simplex 1000 series, Alarm Lock DL-2500, DL-2700 & 3000, Card Access Systems, etc.

For ALUMINUM ENTRANCE doors

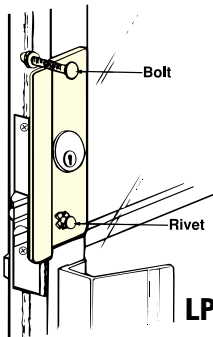

LP-307



NUMBER	DIMENSIONS
LP-307	2 5/8" x 7" x 1/8"

SHELF PACK: 10 Polybagged
FINISHES: 630, DU (Duro Coated), SL (Silver Coated)
12 (.104) Gauge Steel

- Reversible • Fits over cylinder - lock removal NOT required
- Hand carriage bolt and rivet supplied • No specific tools required
- 3/8" offset Display Package Size - 4" x 12"

For ALUMINUM ENTRANCE doors- solves pull handle interference

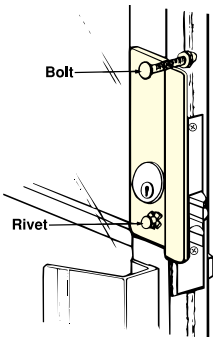

GLP-307
LHR SHOWN



NUMBER	DIMENSIONS
GLP-307 LHR	2 5/8" x 7" x 1/8"
GLP-307 RHR	2 5/8" x 7" x 1/8"

SHELF PACK: 10 Polybagged
FINISHES: 630, DU (Duro Coated), SL (Silver Coated)
12 (.104) Gauge Steel

- Fits over cylinder - lock removal NOT required
- Hand carriage bolt and rivet supplied • No specific tools required
- 3/8" offset
- Center of cylinder hole is 2 1/2" from end of plate Display Package Size - 4" x 12"

For use with CENTER HUNG OUTSWINGING ALUMINUM doors

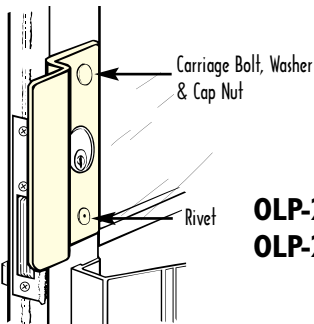

OLP-2650
OLP-2651

NUMBER	DIMENSIONS
OLP-2650	2 5/8" x 6 1/2" x 1 1/8"
OLP-2651	2 5/8" x 6 1/2" x 1 3/8"

SHELF PACK: 10 Polybagged
FINISHES: DU (Duro Coated), SL (Silver Coated)
12 (.104) Gauge Steel

- Available in 1 1/8" and 1 3/8" offset

America's favorite for **OUTSWINGING DOORS** - completely covers the strike plate

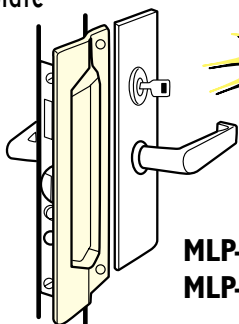

MLP-III
MLP-2II

Now Available in Stainless Steel

SHELF PACK: 10

FINISHES: (MLP-111) 630 12 (.104) Gauge Steel
(MLP-211) SL (Silver Coated), BP (Brass Plated), DU (Duro Coated)

- Furnished with carriage bolts, washers & acorn cap nuts for safety and strength

NUMBER	DIMENSIONS
MLP-111	3" x 11"
MLP-211	3" x 11"

Polybagged

America's favorite for **OUTSWINGING DOORS** - completely covers the strike plate

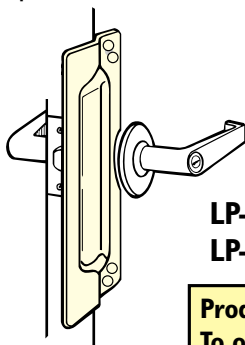

LP-III
LP-2II

Now Available in Stainless Steel

Product available polybagged
To order use 9211

SHELF PACK: 10

FINISHES: (LP-111) 630 Display Package Size - 4" x 16"
(LP-211) BP (Brass Plated) (9211, LP-111) Polybagged
DU (Duro Coated) 12 (.104) Gauge Steel
PC (Prime Coated), SL (Silver Coated)

- Furnished with carriage bolts, washers & acorn cap nuts for safety and strength
- Fits 2 3/4" and 2 3/8" backsets

NUMBER	DIMENSIONS
LP-111	3" x 11"
LP-211	3" x 11"
9211	3" x 11"

Pin Latch protectors for **OUTSWINGING DOORS**

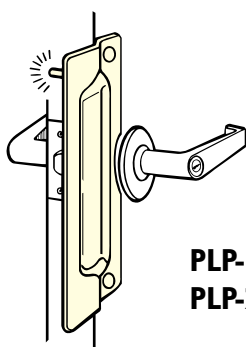

PLP-III
PLP-2II

Now Available in Stainless Steel

SHELF PACK: 10

FINISHES: (PLP-111) 630 Polybagged
(PLP-211) 626, BP (Brass Plated), 12 (.104) Gauge Steel
DU (Duro Coated), SL (Silver Coated)

- Solid steel pin prevents spreading of door from frame • Pin is welded on back leaving no visible point of attack from outside
- Fits 2 3/4" and 2 3/8" backsets

NUMBER	DIMENSIONS
PLP-111	3" x 11"
PLP-211	3" x 11"

Pin Latch protectors for **OUTSWINGING DOORS**

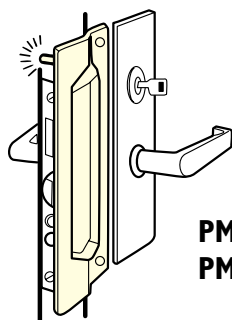

PMLP-III
PMLP-2II

Now Available in Stainless Steel

SHELF PACK: 10

FINISHES: (PMLP-111) 630 Polybagged
(PMLP-211) SL (Silver Coated), 12 (.104) Gauge Steel
BP (Brass Plated), DU (Duro Coated)

- Solid steel pin prevents spreading of door from frame • Pin is welded on back leaving no visible point of attack from outside

NUMBER	DIMENSIONS
PMLP-111	3" x 11"
PMLP-211	3" x 11"



For Outswinging doors

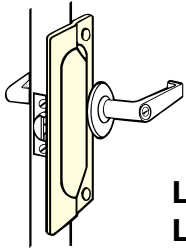

LP-107
LP-207



SHELF PACK: 10
FINISHES: (LP-107) 630
(LP-207) BP (Brass Plated),
DU (Duro Coated), SL (Silver Coated)

Display Package Size - 4" x 12"
12 (.104) Gauge Steel

NUMBER	DIMENSIONS
LP-107	2 3/4" x 7"
LP-207	2 3/4" x 7"

- Furnished with carriage bolts, washers & acorn cap nuts for safety and strength

COMMERCIAL TYPE for outswinging doors

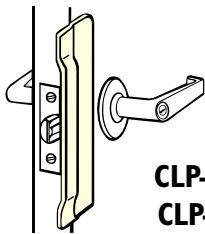

CLP-106
CLP-110



SHELF PACK: 10
FINISHES: 630

Polybagged
12 (.104) Gauge Steel

NUMBER	DIMENSIONS
CLP-106	2 1/8" x 6"
CLP-110	2 1/8" x 10"

- 6" for key-in-knobs • 10" for Mortise Locks • Architectural design
- Concealed welded studs with fasteners

NARROW COMMERCIAL TYPE for outswinging doors

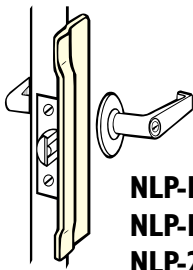

NLP-106
NLP-110
NLP-206
NLP-210



SHELF PACK: 10

FINISHES: (NLP-106, NLP-110) 630
(NLP-206, NLP-210) DU (Duro Coated), PC (Prime Coated),
SL (Silver Coated)

Polybagged
12 (.104) Gauge Steel

NUMBER	DIMENSIONS
NLP-106	1 1/2" x 6"
NLP-110	1 1/2" x 10"
NLP-206	1 1/2" x 6"
NLP-210	1 1/2" x 10"

- 6" for key-in-knobs • 10" for Mortise Locks
- Narrow type for outswinging doors

For KEY-IN-LEVER Locks with up to 3 3/4" ESCUTCHEON

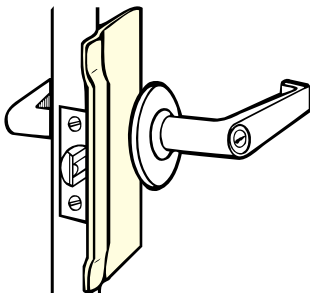

BLP-107
BLP-207

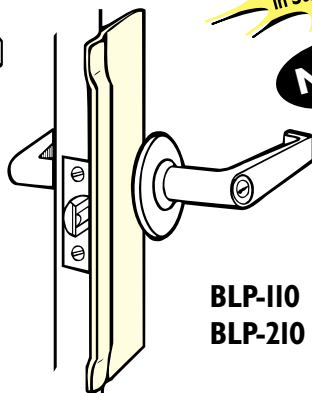

BLP-110
BLP-210



NEW

SHELF PACK: 10

FINISHES: (BLP-107, BLP-110) 630
(BLP-207, BLP-210) BP (Brass Plated), DU (Duro Coated),
SL (Silver Coated)

Polybagged
12 (.104) Gauge Steel

NUMBER	DIMENSIONS
BLP-107	3 1/4" x 7"
BLP-110	3 1/4" x 10"
BLP-207	3 1/4" x 7"
BLP-210	3 1/4" x 10"

- Works with up to 3 3/4" rose • Concealed welded studs with fasteners

For ELECTRONIC LOCKS

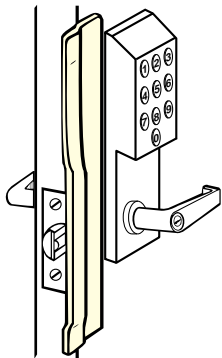

Now Available
in Stainless Steel

"RHR" SHOWN

KLP-110-LHR
KLP-110-RHR

SHELF PACK: 10
FINISHES: 630

- Works with ILCO 1000, 4000
- Alarm Lock Trilogy Locks
- Mas-Hamilton Power Levers
- Schlage Cobra
- Marks I-Q

NUMBER	DIMENSIONS
KLP-110-LHR	1 1/2" x 10"
KLP-110-RHR	1 1/2" x 10"

Polybagged
12 (.104) Gauge Steel

ANGLE TYPE for outswinging doors

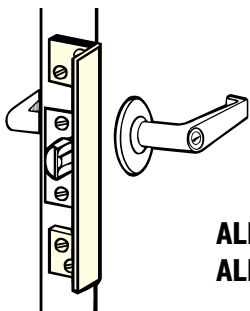

ALP-206
ALP-210

SHELF PACK: 10

FINISHES: BC (Brass Coated), DU (Duro Coated), SL (Silver Coated)

- 6" for key-in-knobs
- 10" for Mortise Locks
- 1 1/2" sheet metal screws for wood or metal

NUMBER	DIMENSIONS
ALP-206	6"
ALP-210	10"

Polybagged
10 (.134) Gauge Steel

Fits FOLGER ADAMS ELECTRIC STRIKE for outswinging doors

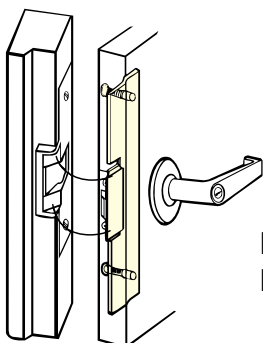

FLP-111
FLP-211

Now Available
in Stainless Steel

SHELF PACK: 10

FINISHES: (FLP-111) 630
(FLP-211) BP (Brass Plated),
DU (Duro Coated),

- Works with Folger Adams 310 & 710 models

NUMBER	DIMENSIONS
FLP-111	1 3/4" x 11 1/4"
FLP-211	1 3/4" x 11 1/4"

Polybagged
12 (.104) Gauge Steel

For use with ELECTRIC STRIKES

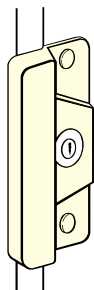

ELP-208
ELP-208P

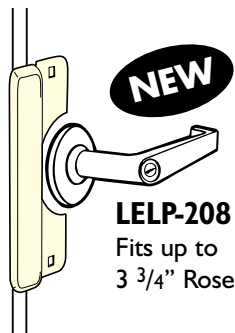

NEW
LELP-208
Fits up to
3 3/4" Rose

SHELF PACK: 10

FINISHES: DU (Duro Coated), SL (Silver Coated)
ELP-208P No Cylinder Hole

- Available with or without cylinder hole
- Designed to fit most electric strikes
- Completely encases the keeper for maximum protection

NUMBER	DIMENSIONS
ELP-208	3 1/2" x 8"
ELP-208P	3 1/2" x 8"
LELP-208	3 1/2" x 8"

Polybagged
12 (.104) Gauge Steel



SHORT TYPE for outswinging doors

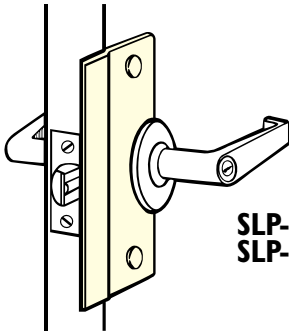

SLP-106
SLP-206



NUMBER	DIMENSIONS
SLP-106	2 1/2" x 6"
SLP-206	2 1/2" x 6"

SHELF PACK: 10

Display Package Size - 4" x 12"
12 (.104) Gauge Steel

FINISHES: (SLP-106) 630
(SLP-206) BP (Brass Plated), DU (Duro Coated),
SL (Silver Coated)

- Furnished with carriage bolts, washers & acorn cap nuts for safety and strength
- May be used on hollow metal door/frame using ANSI strike
- Works with up to 3 3/4" rose

For outswinging ALUMINUM ENTRANCE DOORS

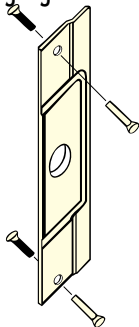

AL-211

NUMBER	DIMENSIONS
AL-211	3 1/2" x 12"

SHELF PACK: 10

Polybagged
12 (.104) Gauge Steel

FINISHES: DU (Duro Coated), SL (Silver Coated)

- Sex nuts and bolts for secure mounting and professional appearance

Fits ADAMS RITE LATCH LOCK for outswinging doors

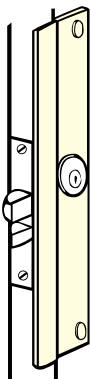

LP-312
LP-312P

NUMBER	DIMENSIONS
LP-312	2 5/8" x 12" x 1/8"
LP-312P	2 5/8" x 12" x 1/8"

SHELF PACK: 10

Polybagged
12 (.104) Gauge Steel

FINISHES: DU (Duro Coated), SL (Silver Coated)
LP-312P No Center Hole

- Reversible
- 1/4" offset - 1 7/16" hole - 1 1/8" backset

SLIMLINE for outswinging doors

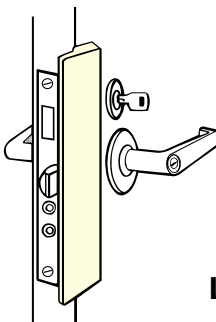

LP-2878

NUMBER	DIMENSIONS
LP-2878	1 1/2" x 8 7/8"

SHELF PACK: 10

Polybagged
5/16" thick (.3125) Gauge Steel

FINISHES: DU (Duro Coated), PC (Prime Coated), SL (Silver Coated)

- Fasteners included
- Sleek appearance



DON-JO MFG., INC.

ALUMINUM FRAME FILLER plates fit selected Folger Adams, Von Duprin, and Rofu numbers

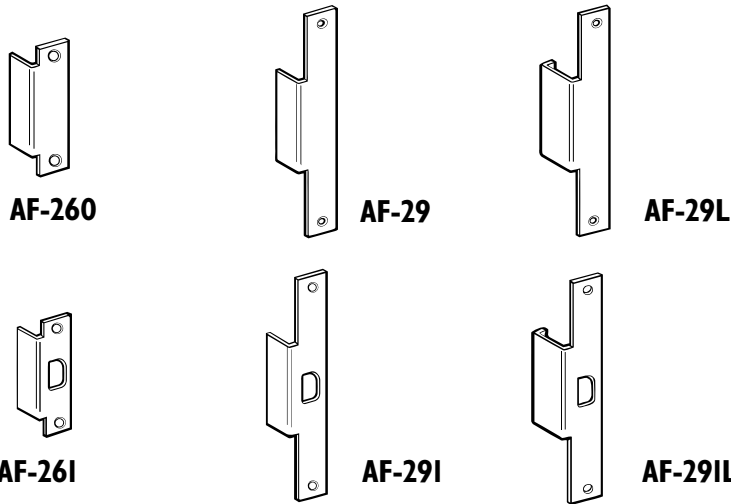

NUMBER	DIMENSIONS
AF-29	9" x 1 ³ / ₈ "
AF-29L	9" x 1 ³ / ₈ "
AF-260	4 ⁷ / ₈ " x 1 ¹ / ₄ "
AF-261	4 ⁷ / ₈ " x 1 ¹ / ₄ "
AF-291	9" x 1 ³ / ₈ "
AF-291L	9" x 1 ³ / ₈ "

SHELF PACK: 10 Polybagged
 FINISHES: DU (Duro Coated), SL (Silver Coated)
 I3 (.095) Gauge Steel

- Electric Strike Filler
- Fits selected Folger Adams, Von Duprin, and Rofu numbers

FILLER PLATES

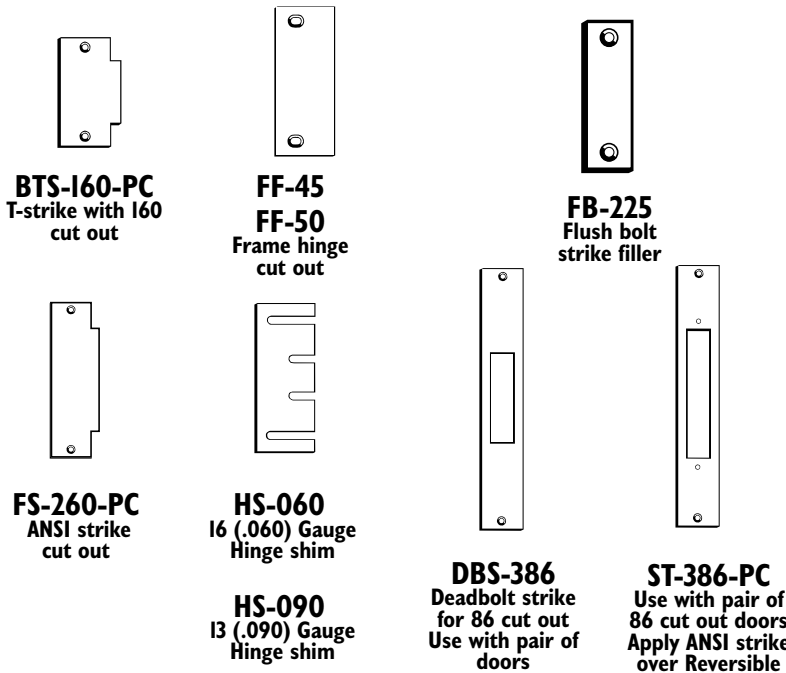

NUMBER	DIMENSIONS
BTS-160	2 ³ / ₄ " x 1 ³ / ₈ "
DBS-386	8" x 1 ¹ / ₄ "
FB-225	2 ¹ / ₄ " x 1 ⁵ / ₁₆ "
FF-45	4 ¹ / ₂ " x 1 ⁵ / ₈ "
FF-50	5" x 1 ⁵ / ₈ "
FS-260	4 ⁷ / ₈ " x 1 ¹ / ₄ "
HS-060	4 ¹ / ₂ " Shims
HS-090	4 ¹ / ₂ " Shims
ST-386	8" x 1 ¹ / ₄ "

SHELF PACK: 10 Polybagged
 FINISHES: PC (Prime Coated)

FILLER PLATE KITS



NUMBER	CONTENTS
FBRK-2	Strike/Reinforcement
FPK-86	EF-86/FS-260
FPK-161	BF-161/EF-161 FS-260

SHELF PACK: 10 Polybagged
 FINISHES: PC (Prime Coated)

FILLER PLATES



CV-86
Converts 86
cut out to 161



CV-2414
Converts Sargent's
Integra locks

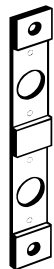

CV-8624
Converts 86
cut out to (2) 161

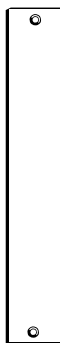

EF-86
LW-86
86 cut out



EL-86
Converts mortise
to electronic
lock



EF-160
160 cut out
EF-161
161 cut out



EF-634
Flush bolt
cut out

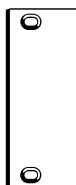

HF-45
SHF-45
Door hinge
cut out

NUMBER	DIMENSIONS
CV-86	8" x 1 1/4"
CV-2414	4 1/4" x 1 1/4"
CV-8624	8" x 1 1/4"
EF-86	8" x 1 1/4" x 3/16"
LW-86	8" x 1 1/4" x 1/4"
EF-160	2 1/4" x 1"
EF-161	2 1/4" x 1 1/8"
EF-161-S	2 3/4" x 1 1/8"
EF-161-TG	2 1/4" x 1 1/8"
EF-634	6 3/4" x 1"
EL-86	8" x 1 1/4"
HF-45	4 1/2" x 1 3/4"
SHF-45	4 1/2" x 1 1/2"

SHELF PACK: 10 Polybagged
FINISHES: (CV-86, CV-8624, EF-86, EF-634, EL-86, LW-86, FB-225, HF-45, SHF-45, EF-161-S, EF-161-TG) **PC** (Prime Coated) (CV-2414) **SL** (Silver Coated) (EF-160, EF-161) **BP** (Brass Plated), **PC** (Prime Coated)

HOLE FILLER PLATES

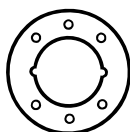

AR-335
Allows for use of levers
on 1 3/8" door

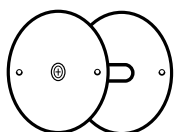

BF-135
Covers up to 3 3/4" hole

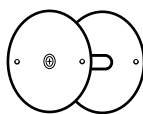

BF-161
Covers up to 2 1/8" hole

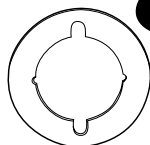

AR-9K
Allows for use of levers
on 1 3/8" door

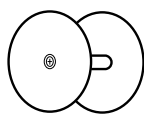

BF-178
Covers up to 1 1/2" hole

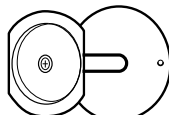

PDF-161
Covers up to 2 1/8" hole
under rim panic device

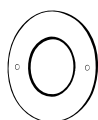

CP-258
2 5/8" cylinder plate -
indents at 3 & 9 o'clock
prevents collar from
shifting on wood or metal

NUMBER	DIMENSIONS
AR-335	3 1/2" Diameter
AR-9K	3 1/2" Diameter
BF-135	3 3/4" Diameter
BF-161	2 5/8" Diameter
VBF-161*	2 3/8" Diameter
BF-178	1 7/8" Diameter
CP-258	2 5/8" Diameter
PDF-161	2 1/8" Hole

SHELF PACK: 10
FINISHES: (AR-335, AR-9K) **605, 613, 630** (BF-135, BF-161, BF-178, CP-258) **BP** (Brass Plated), **PC** (Prime Coated), **SL** (Silver Coated) (PDF-161) **PC** (Prime Coated)
 • CP-258 can be used with Rim or Mortise Cylinders
 • * V indicates product in display packaging



HINGE REINFORCEMENTS

NEW

NUMBER	DESCRIPTION	USED WITH	SIZE	OFFSET	HINGE WEIGHT	GAUGE
HR-100	3 1/2" Hinge Reinforcement	Door/Frame	1 1/16" x 8 1/2"	1/16"	.120	10
HR-110	4" Hinge Reinforcement	Door/Frame	1 1/4" x 10"	3/32"	.124	7
HR-120	4 1/2" Hinge Reinforcement	Door/Frame	1 1/4" x 10"	3/32"	.134	7
HR-130	4 1/2" Hinge Reinforcement	Frames	1 1/2" x 10"	3/32"	.134	7
HR-140	4 1/2" Hinge Reinforcement	Door/Frame	1 1/4" x 10"	1/8"	.190	7
HR-150	4 1/2" Hinge Reinforcement	Frames	1 1/2" x 10"	1/8"	.190	7
HR-160	5" Hinge Reinforcement	Door/Frame	1 1/4" x 10"	3/32"	.146	7
HR-170	5" Hinge Reinforcement	Frames	1 1/2" x 10"	3/32"	.146	7
HR-180	5" Hinge Reinforcement	Door/Frame	1 1/4" x 10"	1/8"	.190	7
HR-190	5" Hinge Reinforcement	Frames	1 1/2" x 10"	1/8"	.190	7
HR-200-4 1/2	4 1/2" Blank Hinge Reinforcement	Door/Frame	1 1/4" x 10"	3/32"	-	7
HR-210-5	5" Blank Hinge Reinforcement	Door/Frame	1 1/4" x 10"	3/32"	-	7
HR-215-4 1/2	4 1/2" Flat Hinge Reinforcement	Doors	1 1/4" x 10"	-	-	7
HR-216-5	5" Flat Hinge Reinforcement	Doors	1 1/4" x 10"	-	-	7
HR-217	6" Hinge Reinforcement	Door/Frame	1 1/4" x 12"	7/64"	.160	7
HR-218	6" Hinge Reinforcement	Door/Frame	1 1/4" x 12"	9/64"	.203	7

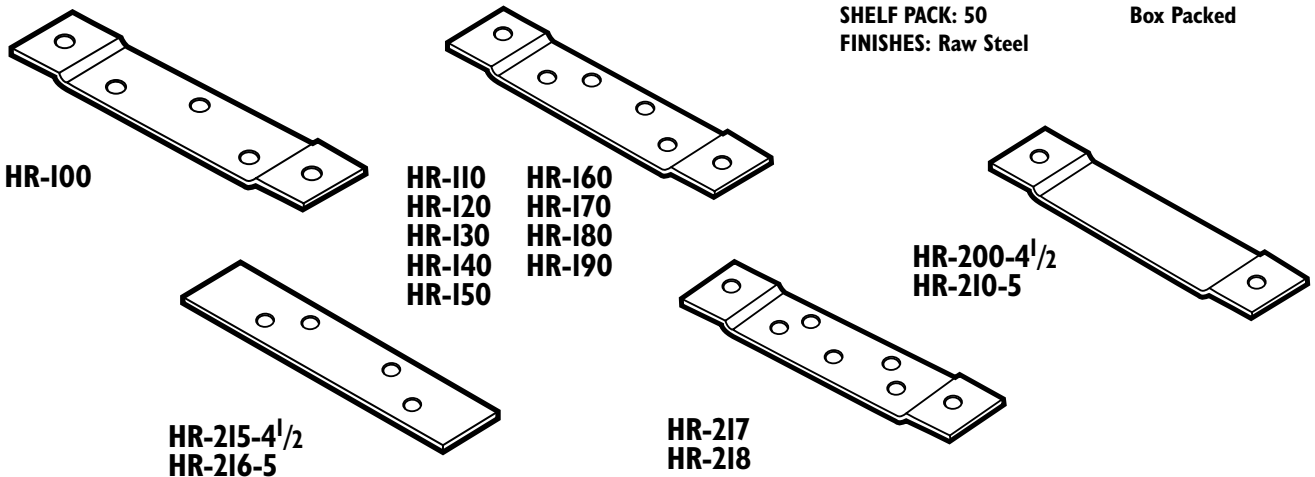

HINGE REINFORCEMENTS

NEW

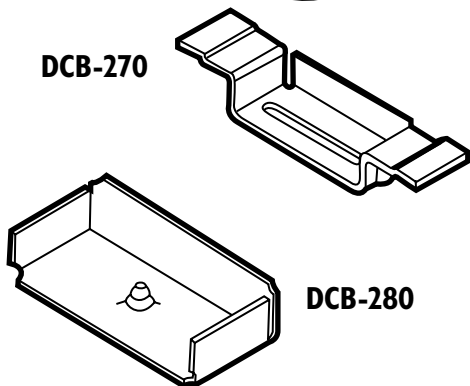

NUMBER	DESCRIPTION	DEPTH	GAUGE
DCB-270	Dust Cover Box/Frame Hinge	3/4"	25
DCB-280	Dust Cover Box/Frame Hinge	5/16"	25

SHELF PACK: 50
FINISHES: Raw Steel

Box Packed

STRIKE REINFORCEMENTS **NEW**

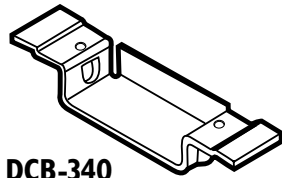

DCB-340

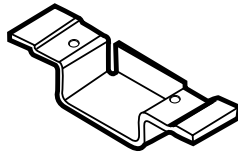

DCB-350

NUMBER	DESCRIPTION
DCB-340	4 ⁷ / ₈ " Strike w/Dust Cover
DCB-350	2 ³ / ₄ " Strike w/Dust Cover

SHELF PACK: 50
FINISHES: Raw Steel

Box Packed

STRAP ANCHORS **NEW**

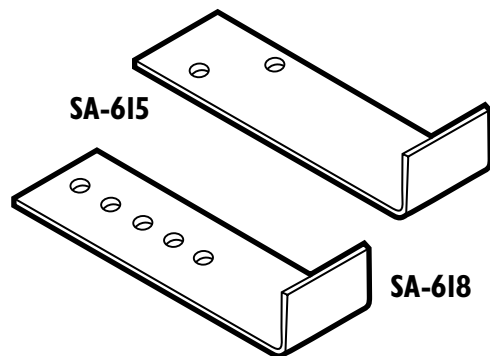

SA-615

SA-618

NUMBER	DESCRIPTION	SIZE	GAUGE
SA-615	Strap Anchor	1" x 4 ¹ / ₂ " x 1 ¹ / ₄ " W	16
SA-618	Strap Anchor	1" x 5" x 1" W	18

SHELF PACK: 50
FINISHES: Raw Steel

Box Packed

SPREADER BARS **NEW**

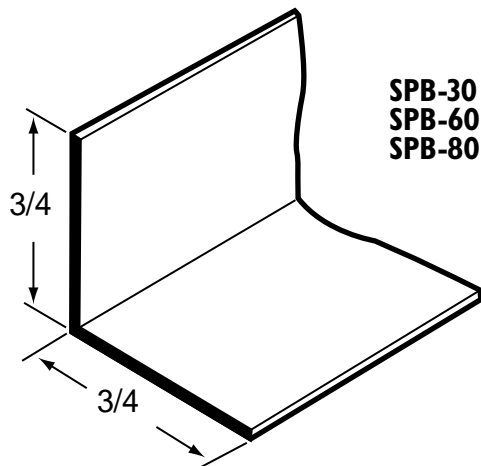

SPB-30
SPB-60
SPB-80

NUMBER	SIZE	LENGTH	GAUGE
SPB-30	3/4" x 3/4"	36"	16
SPB-60	3/4" x 3/4"	72"	16
SPB-80	3/4" x 3/4"	96"	16

SHELF PACK: 50
FINISHES: Raw Steel

Box Packed

TABS

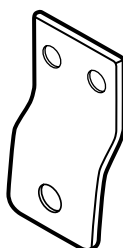

TB-215

NUMBER	DIMENSIONS
TB-215	1" x 1 ¹ / ₂ "

SHELF PACK: 50 Bulk
FINISHES: Zinc Plated



REINFORCEMENT PLATES

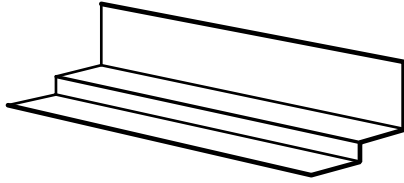

CR-275
Closer
Reinforcement

NUMBER	DIMENSIONS	GAUGE
CR-060	12" x 1 ³ / ₄ "	16 GAUGE
CR-125	12" x 1 ³ / ₄ "	10 GAUGE
CR-275	14" x 4 ¹ / ₈ "	12 GAUGE
CR-300	14" x 4 ¹ / ₈ "	12 GAUGE

SHELF PACK: 10
FINISHES: Raw Steel

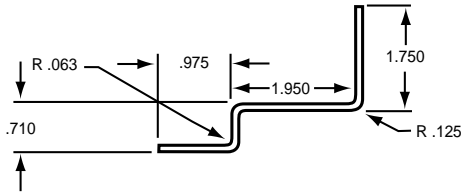

CR-060
16 (.060) Gauge
Closer Reinforcement

CR-125
10 (.125) Gauge
Closer Reinforcement

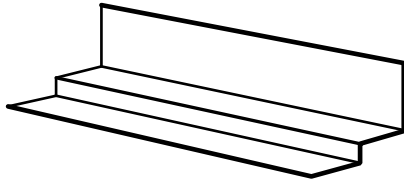

NEW

CR-300
For use with
Parallel arm
closers

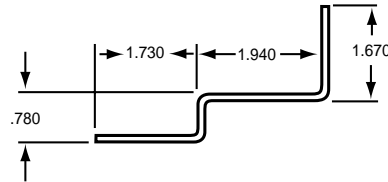

TITLE 24 SIGNS



CHS-1



CHS-2



CHS-3



CHS-4



CHS-5



HS-9070-46



HS-9070-47



HS-9070-48

Sign Size 1³/₄" x 6"

BLUE SIGNS

NUMBER	DESCRIPTION
CHS-1	Men
CHS-2	Women
CHS-3	Restroom
CHS-4	Boys
CHS-5	Girls
HS-9070-46	Men
HS-9070-47	Women
HS-9070-48	Restroom

SHELF PACK: 10 Polybagged

- Raised white lettering
- Braille translation on sign

DECALS

THIS DOOR TO REMAIN UNLOCKED DURING BUSINESS HOURS

DD-1/DD-2

THESE DOORS TO REMAIN UNLOCKED DURING BUSINESS HOURS

DD-3/DD-4



HD-1

NUMBER	DECAL COLOR	DIMENSIONS
DD-1	Black on Clear	1 1/2" x 24"
DD-2	White on Black	1 1/2" x 24"
DD-3	Black on Clear	1 1/2" x 24"
DD-4	White on Black	1 1/2" x 24"
HD-1	White on Blue	4" x 4"

A.D.A. SIGNS



HS-9060-01
HS-9070-01

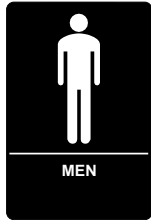

HS-9060-02
HS-9070-02



HS-9060-03
HS-9070-03



HS-9070-07



HS-9060-04
HS-9070-04



HS-9060-05
HS-9070-05



HS-9060-22
HS-9070-22



HS-9070-08

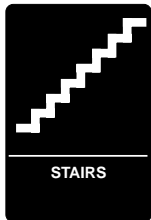

HS-9060-24
HS-9070-24



HS-9060-27
HS-9070-27



HS-9060-32
HS-9070-32



HS-9080-02
HS-9070-06



HS-9060-35
HS-9070-35



HS-9060-36

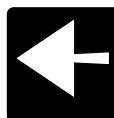

HS-9060-37

BROWN SIGNS

NUMBER	DESCRIPTION
HS-9060-01	Men's/Handicap
HS-9060-02	Men's Room
HS-9060-03	Restrooms
HS-9060-04	Women's Room
HS-9060-05	Women's/Handicap
HS-9060-22	No Smoking
HS-9060-24	Stairs
HS-9060-27	Telephone
HS-9060-32	Women/Men/Handicap
HS-9060-35	Exit
HS-9060-36	Arrow Diagonal
HS-9060-37	Arrow Across
HS-9080-02	Handicap Accessible

(6"x6")
(6"x6")
(6"x6")

BLUE SIGNS

NUMBER	DESCRIPTION
HS-9070-01	Men's/Handicap
HS-9070-02	Men's room
HS-9070-03	Restrooms
HS-9070-04	Women's Room
HS-9070-05	Women's/Handicap
HS-9070-06	Handicap Accessible
HS-9070-07	Boy's/Handicap
HS-9070-08	Girl's/Handicap
HS-9070-22	No Smoking
HS-9070-24	Stairs
HS-9070-27	Telephone
HS-9070-32	Women/Men/Handicap
HS-9070-35	Exit

NEW

(6"x6")

SHELF PACK: 10
 • Sign Size - 6" x 9"
 • Braille translation on sign

Polybagged
 • Raised white lettering
 • A.D.A. compliant



PARTNER PROGRAM

Don-Jo is pleased to announce the innovative "PARTNER PROGRAM". This new program is designed to harness the power of the world wide web to increase your sales of architectural hardware and accessories. Our newly redesigned web site provides you and your customers full access to our entire inventory of products. This will enable all Don-Jo customers to receive their architectural hardware and accessories in a timely and complete manner through our normal distribution channels.

For complete information please contact our sales department at 1-800-628-8389 or email us at sales@don-jo.com





ANSI STRIKES

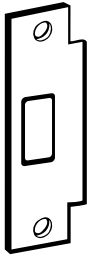

BFD-2
Deadbolt type
for hollow
metal frame

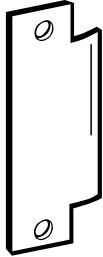

BS-161
Blank
strikes



DBS-1478
DBS-2478
For deadbolt



DST-161
Dimpled type
for use with
roller latch

NUMBER	DIMENSIONS
BFD-2	4 7/8" x 1 1/4"
BS-161	4 7/8" x 1 1/4"
DBS-1478	4 7/8" x 1 1/4"
DBS-2478	4 7/8" x 1 1/4"
DST-161	4 7/8" x 1 1/4"
MST-161	4 7/8" x 1 1/4"
MST-261	4 7/8" x 1 1/4"
ST-134	3 1/4" x 1 1/4"
ST-144	4 1/4" x 1 1/4"
ST-161	4 7/8" x 1 1/4"
ST-261	4 7/8" x 1 1/4"



MST-161
MST-261
Mortise type

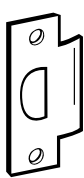

ST-134
Replacement
strike



ST-144
Replacement
strike

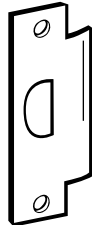

ST-161
ST-261
Standard ANSI

SHELF PACK: 30 Polybagged
FINISHES: (BFD-2) BP (Steel Brass Plated), SL (Silver Coated)
 (BS-161) 605, 612, 626, 630
 (DBS-1478) 605, 626
 (DBS-2478, MST-261) BP (Steel Brass Plated),
 SL (Silver Coated), DU (Duro Coated)
 (DST-161) 605
 (ST-161) 605, 606, 612, 613, 625, 626, 630
 (ST-261) BP (Steel Brass Plated), DU (Duro Coated),
 SL (Silver Coated)
 (ST-134, ST-144) 630
 13 (.095) Gauge Steel
 (MST-161) 630

REPLACEMENT STRIKES



DS-234
Replacement strike

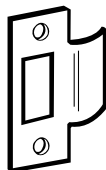

TS-234
T-strike

Product available polybagged
To order use 9234

NUMBER	DIMENSIONS
DS-234	2 3/4" x 1 1/8"
TS-234	2 3/4" x 1 1/8"
9234	2 3/4" x 1 1/8"

SHELF PACK: 30 (DS-234 & 9234) Polybagged
 (TS-234) - Display Packaged
 size - 4" x 6 1/2"
FINISHES: (DS-234) 605, 630
 18 (.050) Gauge

SHELF PACK: 10
FINISHES: (TS-234) 605, 630
 18 (.050) Gauge

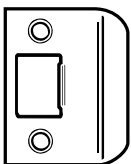

ST-214
Replacement strike

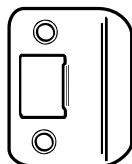

ST-214-RC
Replacement strike

NUMBER	DIMENSIONS
ST-214	2 1/4" x 1 1/4"
ST-214-RC	2 1/4" x 1 1/4"

SHELF PACK: 10 Polybagged
FINISHES: 605, 619, 620, 630, DU (Duro Coated)
 18 (.050) Gauge

2 3/4" EXTENDED LIP STRIKE

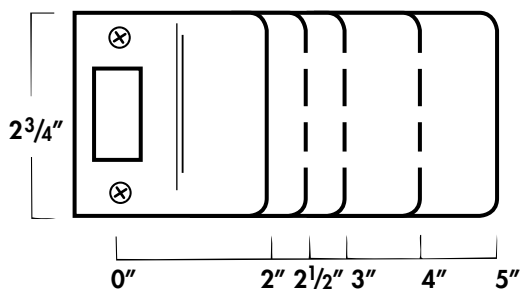

NUMBER	DIMENSIONS
EL-202	2 3/4" x 2"
EL-203	2 3/4" x 3"
EL-204	2 3/4" x 4"
EL-205	2 3/4" x 5"
EL-225	2 3/4" x 2 1/2"

SHELF PACK: 10 Polybagged
 FINISHES: BP (Steel Brass Plated)
 I3 (.095) Gauge

2 1/4" EXTENDED LIP STRIKE

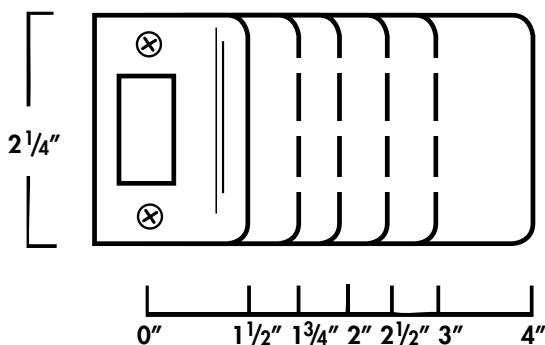

NUMBER	DIMENSIONS
EL-102*	2 1/4" x 2"
EL-103	2 1/4" x 3"
EL-104	2 1/4" x 4"
EL-115	2 1/4" x 1 1/2"
EL-125	2 1/4" x 2 1/2"
EL-175	2 1/4" x 1 3/4"

SHELF PACK: 10 Display Packaged Size - 4" x 6 1/2"
 FINISHES: 605, 609, 619, 620, 630, DU
 I8 (.050) Gauge

Product available polybagged
 To order, replace "EL" with "9".
 I.E., EL-102 will become 9102.

* EL-102- series also available with radius corners

4 7/8" EXTENDED LIP ANSI STRIKE

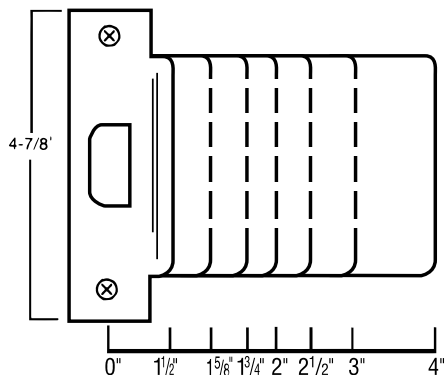

NUMBER	DIMENSIONS
EST-102	4 7/8" x 2"
EST-103	4 7/8" x 3"
EST-104	4 7/8" x 4"
EST-115	4 7/8" x 1 1/2"
EST-125	4 7/8" x 2 1/2"
EST-158	4 7/8" x 1 5/8"
EST-175	4 7/8" x 1 3/4"

SHELF PACK: 5 Polybagged
 FINISHES: 605, 612, 630 I3 (.095) Gauge

2 3/4" EXTENDED LIP T-STRIKE

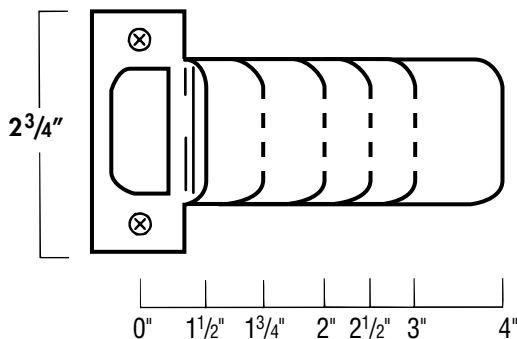

NUMBER	DIMENSIONS
ETS-102	2 3/4" x 2"
ETS-103	2 3/4" x 3"
ETS-104	2 3/4" x 4"
ETS-115	2 3/4" x 1 1/2"
ETS-125	2 3/4" x 2 1/2"
ETS-175	2 3/4" x 1 3/4"

SHELF PACK: 10 Display Packaged Size - 4" x 6 1/2"
 FINISHES: 605, 609, 630 I8 (.050) Gauge



MORTISE TYPE EXTENDED LIP ANSI STRIKE

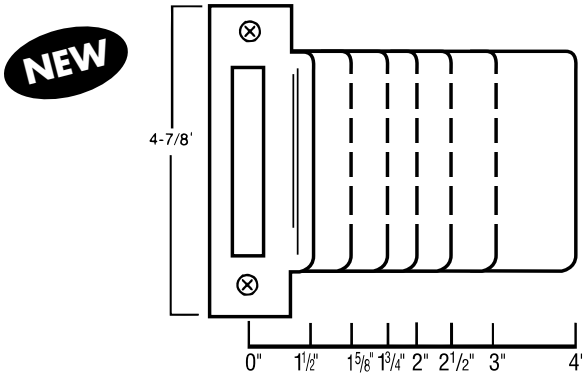

NUMBER	DIMENSIONS
MEST-102	4 7/8" x 2"
MEST-103	4 7/8" x 3"
MEST-104	4 7/8" x 4"
MEST-115	4 7/8" x 1 1/2"
MEST-125	4 7/8" x 2 1/2"
MEST-158	4 7/8" x 1 5/8"
MEST-175	4 7/8" x 1 3/4"

SHELF PACK: 5
FINISHES: 630

Polybagged
I3 (.095) Gauge Steel

THIMBLE STRIKE

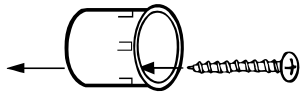

TS-100
Thimble strike

NUMBER	DIMENSIONS
TS-100	1" Diameter

SHELF PACK: 20
FINISHES: BP (Brass Plated), CP (Chrome Plated)

Polybagged

SECURITY STRIKES

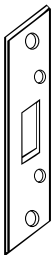

2-SDS
For deadbolt



2-SS
For key-in-knob

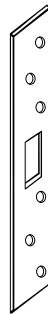

2-SDS-8
Super strike for deadbolt

NUMBER	DIMENSIONS
2-SDS	4 7/8" x 1 1/4"
2-SS	4 7/8" x 1 1/4"
2-SDS-8	8" x 1 3/8"

SHELF PACK: 10 Display Packaged Size - 4" x 7 3/4"
FINISHES: BP (Steel Brass Plated), SL (Steel Silver Coated)
I3 (.095) Gauge Steel

- Super Strike: Display Packaged Size - 4" x 16"
- Supplied with four 3" screws for extra security

DOUBLE LIP STRIKES

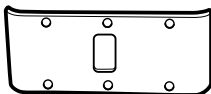

DL-II
Center Hung

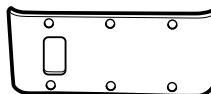

DL-I2

NUMBER	DIMENSIONS
DL-II	5 3/4" x 2 3/4"
DL-I2	5 3/4" x 2 3/4"

SHELF PACK: 10
FINISHES: 630

Polybagged

I3 (.095) Gauge Steel



SERIES-8, SERIES-12 AND SERIES-18 STRIKES

Single hole version designed to work with key-in-knob or deadbolt

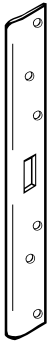

AST-21341
AST-21381
FL-208N
FL-208W
FL-212N
FL-212W

Double hole version designed to accommodate both 3 7/8" & 4" centered locksets



AST-21342
AST-21382
FL-212N4
FL-212W4

Double hole version designed to accommodate 6" center holes

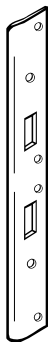

AST-21346
AST-21386
FL-212N6
FL-212W6

Mortise hole version with "universal" center hole

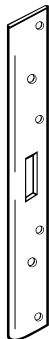

AST-2134M
AST-2138M
FL-208NM
FL-208WM
FL-212NM
FL-212WM

NUMBER	DIMENSIONS
AST-21341	18" x 1 3/4"
AST-21381	18" x 1 3/8"
FL-208N	8" x 1 3/8"
FL-208W	8" x 1 3/4"
FL-212N	12" x 1 3/8"
FL-212W	12" x 1 3/4"
AST-21342	18" x 1 3/4"
AST-21382	18" x 1 3/8"
FL-212N4	12" x 1 3/8"
FL-212W4	12" x 1 3/4"
AST-21346	18" x 1 3/4"
AST-21386	18" x 1 3/8"
FL-212N6	12" x 1 3/8"
FL-212W6	12" x 1 3/4"
AST-2134M	18" x 1 3/4"
AST-2138M	18" x 1 3/8"
FL-208NM	8" x 1 3/8"
FL-208WM	8" x 1 3/4"
FL-212NM	12" x 1 3/8"
FL-212WM	12" x 1 3/4"

SHELF PACK: 10 Polybagged
FINISHES: (AST-21341, AST-21346, AST-2134M, FL-208W, FL-212W, FL-212W4)
BP (Brass Plated), SL (Silver Coated), WH (White Coated)
(AST-21381, AST-21382, AST-21386, AST-2138M, FL-208N, FL-208NM, FL-212N, FL-212N4, FL-212N6, FL-212NM, FL-212W6, FL-212WM)
BP (Brass Plated)
(AST-21342, FL-208WM)
BP (Brass Plated), SL (Silver Coated)
I3 (.095) Gauge Steel

SHELF PACK: 10 Display Packaged Size - 4" x 16"
FINISHES: (FL-212N6, FL-212NM) **BP (Brass Plated)**
(FL-212W6, FL-212WM) **BP (Brass Plated), SL (Silver Coated), WH (White Coated)**
I3 (.095) Gauge Steel



SECURITY STRIKES

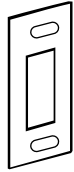

A-2-SDS
Adjustable for
deadbolt



A-2-SS
Adjustable for
key-in-knob

NUMBER	DIMENSIONS
A-2-SDS	1 1/4" x 3 3/8"
A-2-SS	1 3/4" x 3 3/8"

SHELF PACK: 10 Polybagged
FINISHES: BP (Steel Brass Plated), SL (Steel Silver Coated)
I3 (.095) Gauge Steel

FINISH DESCRIPTIONS

BHMA CODE	FINISH DESCRIPTION	FINISH CODE	BHMA CODE	FINISH DESCRIPTION	FINISH CODE
605	BRASS – Polished, Lacquered	US-3	625	BRASS – Chrome, Bright	US-26
606	BRASS – Dull, Satin Lacquered	US-4	626	BRASS – Chrome, Dull	US-26D
609	BRASS – Dull, Oxidized, Relieved & Lacquered	US-5	628	ALUMINUM – Anodized	US-28
612	BRONZE – Dull, Satin Lacquered	US-10	(BT)	ALUMINUM – Gold, Anodized	US-28G
613	BRONZE – Oxidized, Oil Rubbed	US-10B	629	STAINLESS STEEL – Polished	US-32
619	NICKEL PLATE – Dull	US-15	630	STAINLESS STEEL – Satin	US-32D
620	NICKEL PLATE – Satin, Oxidized & Relieved	US-15A	(EN)	ENDURANCE	EN
622	BLACK – Dull	US-1			

FASTENERS

PART NO.	USED ON	APPROX. QTY	FINISH	PART NO.	USED ON	APPROX. QTY	FINISH
Drive-In Rivet	LP-307	72 per 1/2 lb.	Zinc Duro	#8 x 3/4" Phillips Truss Head	Trim Screws Wrap-Around Plates	226 per lb	Brass Plated Zinc Plated
#10 x 3" Phillips Head Wood Screw	Security Strikes	54 per 1/2 lb	Brass Plated Zinc Plated	#8 - 32 x 3/4" Phillips Head Combination	Face Plate Screws	147 per 1/4 lb	Brass Plated Zinc Plated
#12 - 24 x 1" Phillips Head Combination Screw	ANSI Strikes	133 per lb	Brass Plated Zinc Plated Dark Brown	#6 - 5/8" Phillips Oval Head Stainless Steel	Push, Kick Plate Screws	115 per 1/4 lb	Brass Plated Zinc Plated
#12 - 24 x 1/2" Phillips	FS-260	205 per lb	Parkerized	Speed Nuts	Flat Front Wrap-Around	116 per 1/2 lb	Black
#8 - 32 x 1/2" Phillips	EF-161	180 per 1/2 lb	Zinc Plated	#10 - 1 1/2" S.M.S. Screws	ALP Series	124 per lb	Brass Plated Zinc Plated Dark Brown
#10 x 1 1/4" One Way Screws	ILP Series	135 per lb	Brass Plated Zinc Plated Dark Brown	NOTE: When ordering please use part number and specify finish. Sold only in above quantity packages. All quantities are approximate amounts.			



POCKET DOOR LOCKS

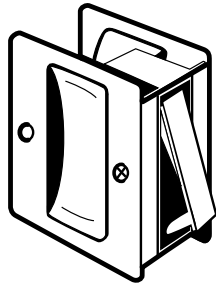

PDL-100
Passage

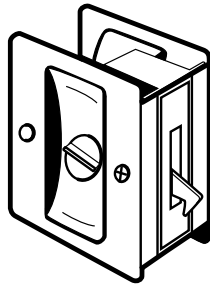

PDL-101
Privacy

NUMBER	DIMENSIONS	ANSI
PDL-100	2 1/2" x 2 3/4"	D082 I
PDL-101	2 1/2" x 2 3/4"	D083 I

- SHELF PACK: 10** **Box Packed**
FINISHES: 605, 609, 613, 619, 620, 622, 625, 626, 605x625
- Field Reversible
 - Adjustable for various door thickness
 - Includes pin & screws for 1 3/4" door width

SCAR PLATES used to convert 2 3/8" to 2 3/4" backset

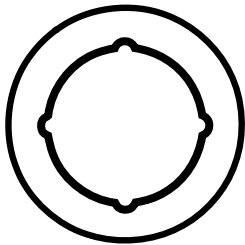

SP-135

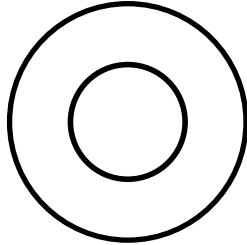

DSP-135

NUMBER	DIMENSIONS
SP-135	3 1/2" O.D.
DSP-135	3 1/2" O.D.

- SHELF PACK: 10** **Display Package Size - 5 1/4" x 6 1/2"**
FINISHES: 605, 609, 612, 630
- SP-135 fits under rose of key-in-knob or deadbolt locks
 - DSP-135 fits under deadbolt collars

Product available polybagged
 To order, add prefix "PB".
 I.E., SP-135 will become PBSP-135.

REMODELER PLATES for modernizing or decorating

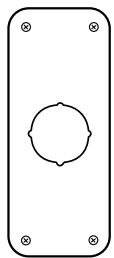

RP-13509

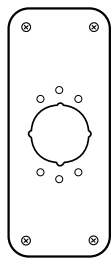

RP-13509-2

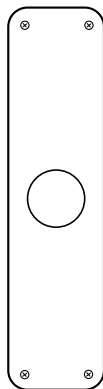

RP-13515

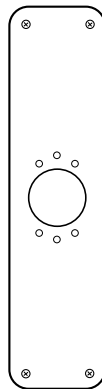

RP-13515-2

NUMBER	DIMENSIONS
RP-13509	3 1/2" x 9"
RP-13509-2	3 1/2" x 9"
RP-13515	3 1/2" x 15"
RP-13515-2	3 1/2" x 15"
RP-13545	3 1/2" x 4 1/2"
RP-13545-2	3 1/2" x 4 1/2"
RPK-109	3 1/2" x 9"

- SHELF PACK: 10** **Display Packaged Size - 7 1/2" x 13"**
Polybagged
- FINISHES: (RP-13509, RP-13509-2, RP-13545, RP-13545-2) 605, 609, 612, 630**
(RP-13515, RP-13515-2, RP-109) 605, 630
 .032 thick

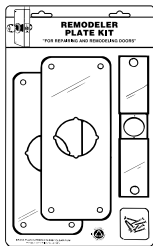

RPK-109

Kit Contains:
(2) RP-13509
(1) CV-86-C & all fasteners

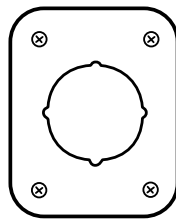

RP-13545

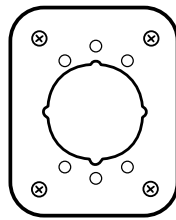

RP-13545-2

DOOR VIEWERS

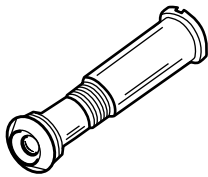

DV-90
ULDV-90
1/2" installation hole

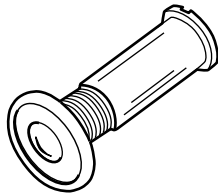

DV-180
ULDV-180
9/16" installation hole

NUMBER	VIEW DIMENS.	ANSI
DV-90	160 Degrees	L21372
DV-180	180 Degrees	L21371
ULDV-90	160 Degrees	L23222
ULDV-180	180 Degrees	L23221



SHELF PACK: 10
FINISHES: 605, 626
Polybagged
• For doors 1 3/8" to 2" thickness
• DV-90 and DV-180 with plastic lens
• ULDV-90 and ULDV-180 with glass lens are UL rated

HANDRAIL BRACKETS

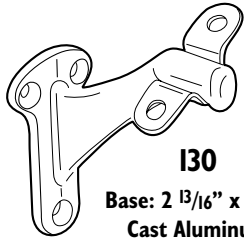

I30
Base: 2 13/16" x 1 1/2"
Cast Aluminum

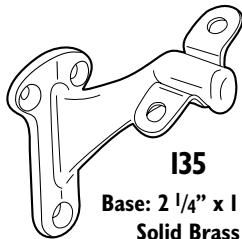

I35
Base: 2 1/4" x 1 1/4"
Solid Brass

NUMBER	MATERIAL	ANSI
I30	Cast Aluminum	L33061
I35	Solid Brass	L13061

SHELF PACK: (I30) 20 , (I35) 10
FINISHES: I30: 605, 609, 613, 619, 620, 625, 626
I35: 605, 613, 619, 620, 626
Polybagged

DOOR FLIP GUARDS

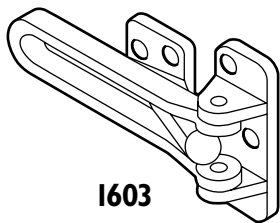

I603

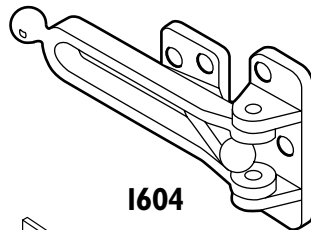

I604



AP-34
1" x 1" x 1/2"



WP-34
1" x 1"

NUMBER	MATERIAL	ANSI
I603	Aluminum	L33042
I604	Brass	L13042
AP-34	-	-
WP-34	-	-

SHELF PACK: (I603, I604) 10
(AP-34, WP-34) 100
FINISHES: (I603, I604) 605, 606, 625, 626
(AP-34) 605, 606, 626
(WP-34) 605, 606, 626, Clear
• Black rubber shim available for I603 and I604
• AP-34 included with item I604
• Both models feature Ball Bearing Design

CHAIN GUARD

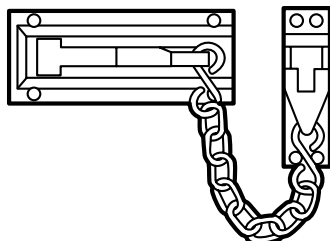

I607

NUMBER	MATERIAL
I607	Cast Brass

SHELF PACK: 20
FINISHES: Brass
Polybagged

SOLID BRASS REPLACEMENT KNOBS

BK-225

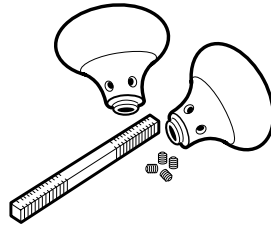

NUMBER	DIMENSIONS
BK-225	2 1/4"

SHELF PACK: 10 Display Packaged
 FINISHES: Solid Brass
 • Includes spindle, 4 set screws & 2 knobs

ELBOW CATCH

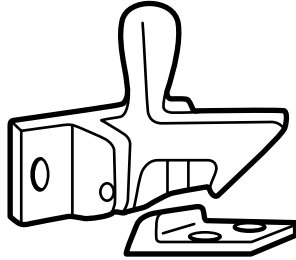

1590

NUMBER	MATERIAL
1590	Cast

SHELF PACK: 10 Polybagged
 FINISHES: 605, 625

HINGE PINS/WINDOW BOLTS

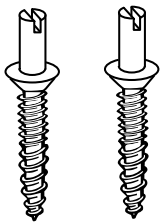

CHP-100
RHP-100

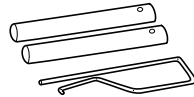

WB-112

NUMBER	DIMENSIONS
CHP-100	#12 Head
RHP-100	#10 Head
WB-112	Contains: 8 Bolts, 4 Tools

SHELF PACK: (CHP-100, RHP-100) 10 pack of 2 each Polybagged
 (WB-112) 10
 FINISHES: (CHP-100, RHP-100) BP (Brass Plated),
 CP (Chrome Plated)
 (WB-112) ZINC

COAT HOOKS

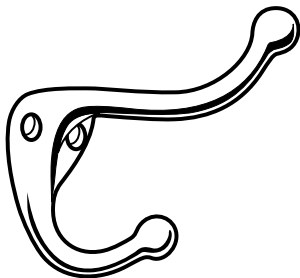

300

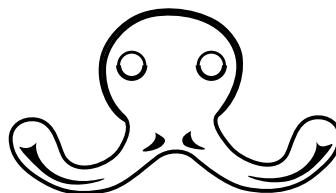

302

NUMBER	MATERIAL
300	Die Cast
302	Die Cast

SHELF PACK: 20 Polybagged
 FINISHES: 605, 613, 619, 620, 625

FINGER PULL

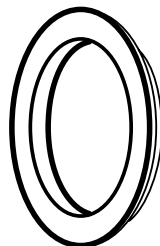

125

NUMBER	DIMENSIONS	MATERIAL
125	2 1/8"	Zinc

SHELF PACK: 50 Polybagged
 FINISHES: 605, 609, 613, 619, 620, 625, Black

SCAR PLATE for door damaged by prying

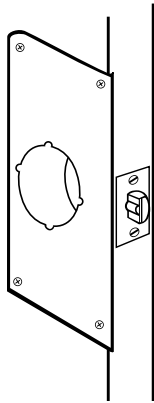

EM-2
EM-4

NUMBER	DIMENSIONS
EM-2	9" x 4" x 2 3/8"
EM-4	9" x 4 1/4" x 2 3/8"

SHELF PACK: 10 Polybagged
 FINISHES: 605, 630
 • Fits one side of door with curved lip
 • Fits under key-in-knob

CRASH CHAIN

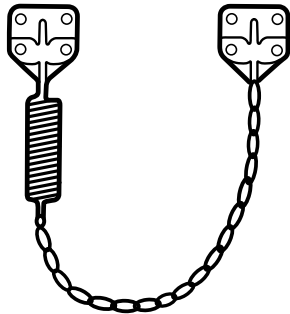

CC-100

NUMBER	CHAIN SIZE
CC-100	21 3/4"

SHELF PACK: 20 Polybagged
 FINISHES: Zinc
 • Vinyl Cover

EDGE PULLS

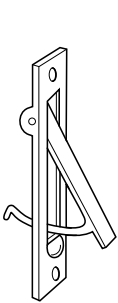

104

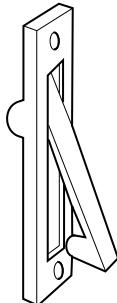

106

NUMBER	DIMENSIONS
104	3 7/8" x 3/4"
106	6" x 1 1/4"

SHELF PACK: 10 Polybagged
 FINISHES: 605, 613, 619, 620, 626

NUMBERS/DOOR KNOCKERS

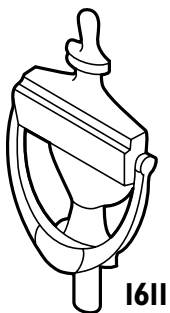

1611

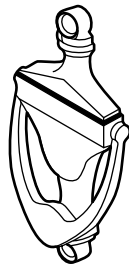

1613



BN4 -

NUMBER	DIMENSIONS	ANSI
1611	6 7/8" x 3 1/2"	L13151
1613	3 7/8" x 2 1/4"	L13151
BN4-	4"	-

SHELF PACK: 10 Polybagged
 FINISHES: 605
 • Forged Brass

How to Order:
 eg: BN4-2-605